



Solid Carbide Tools

An ISO 9001: 2000 Certified Company

Bur Catalog

***Fractional
&
Metric***

***Serving Industry
for over 50 Years***

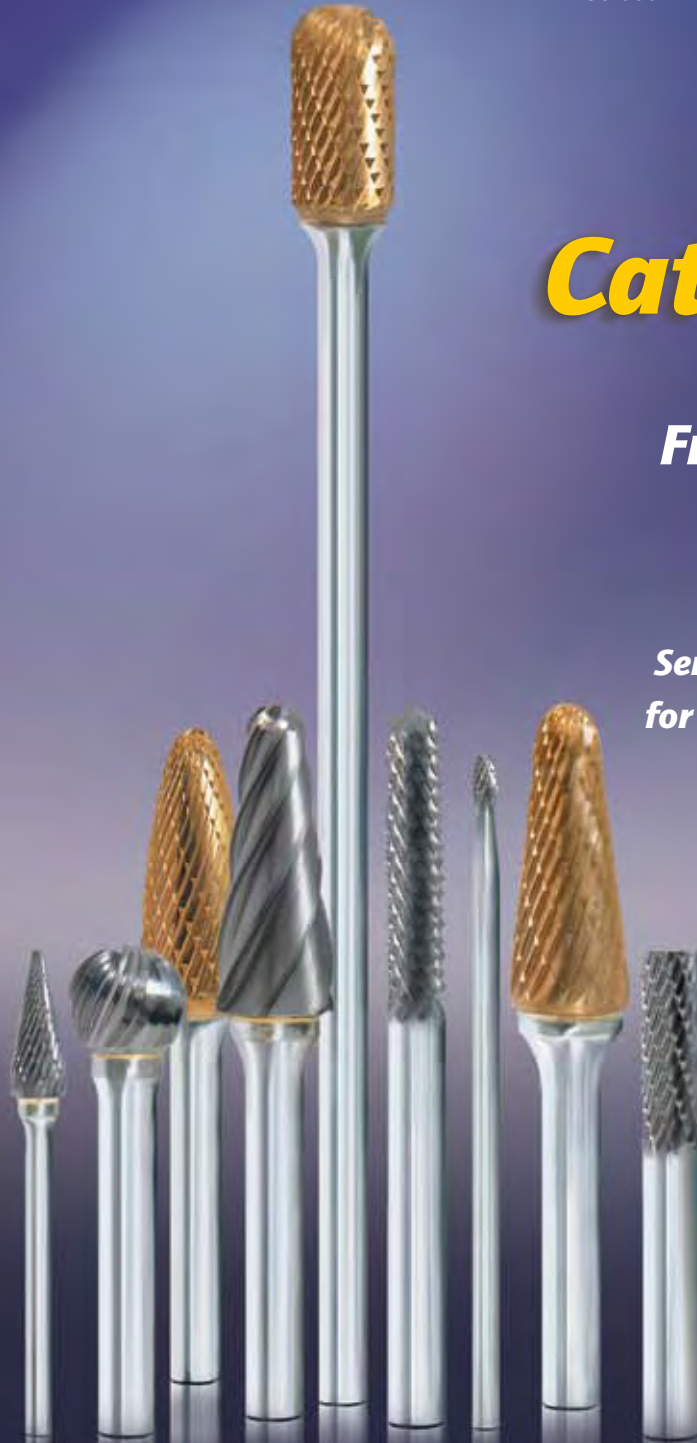



Solid Carbide Tools

SOLID CARBIDE BURS

Features and Benefits

- ***Full line for a wide range of applications***
- ***Ferrous and nonferrous configurations for excellent finishes and efficient stock removal***
- ***Thirteen head shapes***
- ***A wide range of fluting styles***
- ***Extra-long shanks available***
- ***Miniature burs***
- ***Automated temperature-controlled brazing***
- ***Special configurations available to meet specific application requirements***
- ***Machine-ground cutting flutes***
- ***Tool-to-Tool consistency***
- ***Complete resharpener services available***
- ***Lab inspected raw materials***

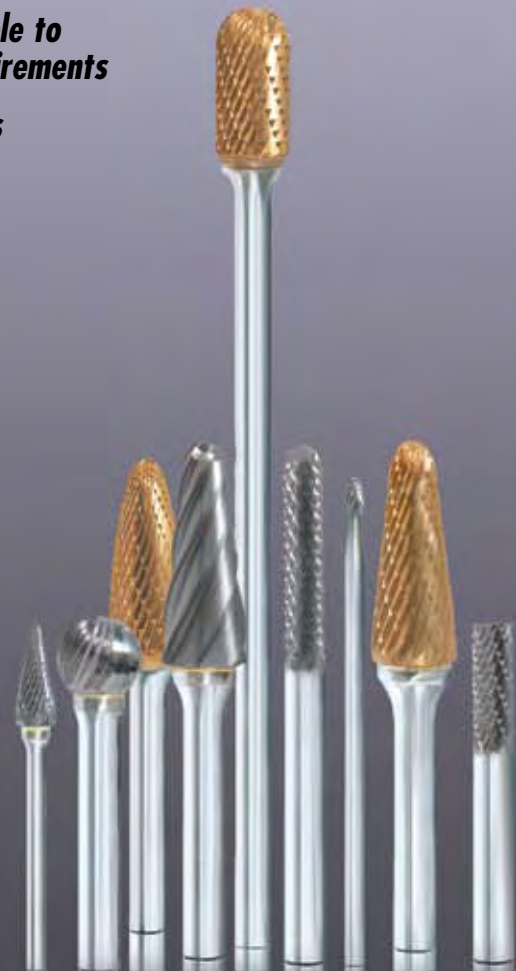

Table of Contents

Solid Carbide Burs

E

ES

FR

| Fractional Burs | Rotativas Fraccionario | Fraises - Limes | Page |
|-----------------------------------|---|---|-------|
| SA Cylinder Shape | Limas rotativas forma cilíndrica | Fraises - Limes forma cylindrique | 4 |
| SB Cylinder Shape with End Cut | Limas rotativas en forma cilíndrica con corte frontal | Fraises - Limes Forma cylindrique avec denture en bout | 5 |
| SC Cylinder Shape with Radius End | Limas rotativas en forma cilíndrica con radio | Fraises-limes de forme cylindrique à bout hémisphérique | 6 |
| SD Ball Shape | Limas rotativas esféricas | Fraises-limes de forme sphérique | 7 |
| SE Oval Shape | Limas rotativas en forma ovalada | Fraises-limes de forme ovale | 8 |
| SF Tree Shape with Radius End | Limas rotativas en forma de árbol | Fraises-limes en forme d'ogive à bout hémisphérique | 9 |
| SG Tree Shape with Pointed End | Limas rotativas en forma de árbol puntiagudo | Fraises-limes en forme d'ogive à bout pointu | 10 |
| SH Flame Shape | Limas rotativas en forma de llama | Fraises-limes en forme de flamme | 11 |
| SJ, SK 60° & 90° Cone Shape | Limas rotativas cónica | Fraises-limes de forme conique | 12 |
| SL Taper Shape with Radius End | Limas rotativas cónicas con radio en la punta | Fraises-limes de forme conique, à bout hémisphérique | 13 |
| SM, SN Cone & Inverted Cone Shape | Limas rotativas cónicas, cónica invertida | Fraises-limes de forme conique et conique inversée | 14 |
| Long Shank | Limas rotativas con zanco largo | Fraises-limes à queue longue | 15-16 |
| Mold, Tool & Die Making | Limas rotativas para moldes, herramientas y matrices | Fraises-limes pour moulistes, outils et matrices | 17-18 |
| Bur Sets | Juego de limas rotativas | Coffrete | 19-21 |

| Fiberglass Routers | Fresas De Contornear | Fraises Pour Detourage | Page |
|---------------------------------|--|---------------------------------------|------|
| Fiberglass Routers - Fractional | Fresas para fibra de vidrio - Fraccionario | Fraises pour fibre de verre - Partiel | 22 |

| Metric Burs | Rotativas - Métrico | Fraises-Limes Métrique | Page |
|-------------------------------------|---|---|-------|
| SA Cylinder Shape | Limas rotativas forma cilíndrica | Fraises - Limes forma cylindrique | 24 |
| SB Cylinder Shape with End Cut | Limas rotativas en forma cilíndrica con corte frontal | Fraises - Limes Forma cylindrique avec denture en bout | 25 |
| SC Cylinder Shape with Radius End | Limas rotativas en forma cilíndrica con radio | Fraises-limes de forme cylindrique à bout hémisphérique | 26 |
| SD Ball Shape | Limas rotativas esféricas | Fraises-limes de forme sphérique | 27 |
| SE Oval Shape | Limas rotativas en forma ovalada | Fraises-limes de forme ovale | 28 |
| SF Tree Shape with Radius End | Limas rotativas en forma de árbol | Fraises-limes en forme d'ogive à bout hémisphérique | 29 |
| SG Tree Shape Burs with Pointed End | Limas rotativas en forma de árbol puntiagudo | Fraises-limes en forme d'ogive à bout pointu | 30 |
| SH Flame Shape | Limas rotativas en forma de llama | Fraises-limes en forme de flamme | 31 |
| SJ, SK 60° & 90° Cone Shape | Limas rotativas cónica | Fraises-limes de forme conique | 32 |
| SL Taper Shape Burs with Radius End | Limas rotativas cónicas con radio en la punta | Fraises-limes de forme conique, à bout hémisphérique | 33 |
| SM, SN Cone & Inverted Cone Shape | Limas rotativas cónicas, cónica invertida | Fraises-limes de forme conique et conique inversée | 34 |
| Mold, Tool & Die Making | Limas rotativas para moldes, herramientas y matrices | Fraises-limes pour moulistes, outils et matrices | 35-36 |
| Bur Sets | Juego de limas rotativas | Coffrete | 37 |

| Fiberglass Routers | Fresas De Contornear | Fraises Pour Detourage | Page |
|-----------------------------|---------------------------------------|--|------|
| Fiberglass Routers - Metric | Fresas para fibra de vidrio - Métrico | Fraises pour fibre de verre - Métrique | 38 |

| Technical Recommendations | Recomendaciones Técnicas | Préconisations | Page |
|---------------------------|--------------------------|----------------|------|
| | | | 39 |

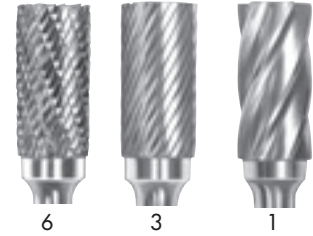
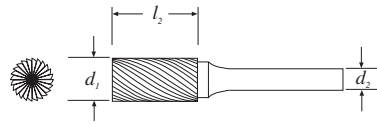

E

Cylinder Shape Burs

Solid Carbide

* 3/8" shanks optional

To Order Optional Cuts 4, 3SP, 2, 5 – Specify Quantity, Tool No. & Optional Cut

- Complete Bur Regrind Service Available

ES

Limas rotativas forma cilíndrica

Carburo sólido

* Zanco de 3/8" opcional.

Para ordenar cortes opcionales 4, 3SP, 2, y 5 : Especifique la cantidad, no. de herramienta y tipo de corte opcional.

- Disponemos de un servicio completo de reafileado de limas rotativas

FR

Fraises - Limes forme cylindrique

Carbure monobloc

* Queue de 3/8" en option.

Pour commander les coupes en option 4, 3SP, 2, 5 : indiquer la quantité, le N° d'outil et la coupe.

- Service de réaffûtage complet de fraises rotatives disponible

| Tool No. | Cutter Diameter d_1 | Length of Cut l_2 | Shank Diameter d_2 | Double Cut EDP No. | Single Cut EDP No. | Nonferrous Cut EDP No. |
|-----------|--------------------------|------------------------|-------------------------|-----------------------|-----------------------|---------------------------|
| SA-41 | 1/16 | 1/4 | 1/8 | 10603 | 10600 | |
| SA-41L2 | 1/16 | 1/4 | 1/8 | 17103 | 17100 | |
| SA-41L3 | 1/16 | 1/4 | 1/8 | 17128 | 17125 | |
| SA-61 | 1/16 | 1/4 | 3/32 | 10753 | 10750 | |
| SA-63 | 3/32 | 3/8 | 3/32 | 10778 | 10775 | |
| SA-42 | 3/32 | 7/16 | 1/8 | 10628 | 10625 | |
| SA-42L2 | 3/32 | 7/16 | 1/8 | 17153 | 17150 | |
| SA-42L3 | 3/32 | 7/16 | 1/8 | 17178 | 17175 | |
| SA-11 | 1/8 | 1/2 | 1/4 | 10403 | 10400 | |
| SA-43 | 1/8 | 9/16 | 1/8 | 10653 | 10650 | |
| SA-43L2 | 1/8 | 9/16 | 1/8 | 17203 | 17200 | |
| SA-43L3 | 1/8 | 9/16 | 1/8 | 17228 | 17225 | |
| SA-12 | 1/8 | 5/8 | 1/4 | 10428 | 10425 | |
| SA-52 | 5/32 | 1/2 | 1/8 | 10703 | 10700 | |
| SA-13 | 5/32 | 5/8 | 1/4 | 10453 | 10450 | |
| SA-81 | 3/16 | 5/8 | 3/16 | 10803 | 10800 | |
| SA-53 | 3/16 | 1/2 | 1/8 | 10728 | 10725 | |
| SA-14 | 3/16 | 5/8 | 1/4 | 10478 | 10475 | |
| SA-51 | 1/4 | 1/2 | 1/8 | 10678 | 10675 | |
| SA-1 | 1/4 | 5/8 | 1/4 | 10003 | 10000 | |
| SA-1L | 1/4 | 1 | 1/4 | 10028 | 10025 | |
| SA-1L6 | 1/4 | 1/2 | 1/4 | 16178 | 16175 | |
| SA-1NF | 1/4 | 3/4 | 1/4 | | | 19000 |
| SA-2 | 5/16 | 3/4 | 1/4 | 10053 | 10050 | |
| SA-3 | 3/8 | 3/4 | 1/4 | 10078 | 10075 | |
| SA-3L | 3/8 | 1 | 1/4 | 10103 | 10100 | |
| SA-3L6 | 3/8 | 3/4 | 1/4 | 16203 | 16200 | |
| SA-3NF | 3/8 | 3/4 | 1/4 | | | 19002 |
| SA-3X | 3/8 | 1-1/2 | 1/4 | 10128 | 10125 | |
| SA-4 | 7/16 | 1 | 1/4 | 10153 | 10150 | |
| SA-5 | 1/2 | 1 | 1/4 | 10178 | 10175 | |
| SA-5L6 | 1/2 | 1 | 1/4 | 16228 | 16225 | |
| SA-5NF | 1/2 | 1 | 1/4 | | | 19004 |
| * SA-6 | 5/8 | 1 | 1/4 | 10203 | 10200 | |
| * SA-6NF | 5/8 | 1 | 1/4 | | | 19006 |
| * SA-15 | 3/4 | 1/2 | 1/4 | 10503 | 10500 | |
| * SA-16 | 3/4 | 3/4 | 1/4 | 10553 | 10550 | |
| * SA-7 | 3/4 | 1 | 1/4 | 10253 | 10250 | |
| SA-7NF | 3/4 | 1 | 1/4 | | | 19008 |
| SA-7NF3/8 | 3/4 | 1 | 3/8 | | | 19010 |
| * SA-8 | 7/8 | 1 | 1/4 | 10303 | 10300 | |
| * SA-9 | 1 | 1 | 1/4 | 10353 | 10350 | |



TECHNICAL

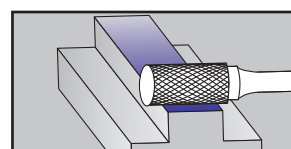
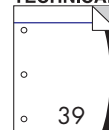

SB Burs - Cylinder Shape - End Cut - Fractional

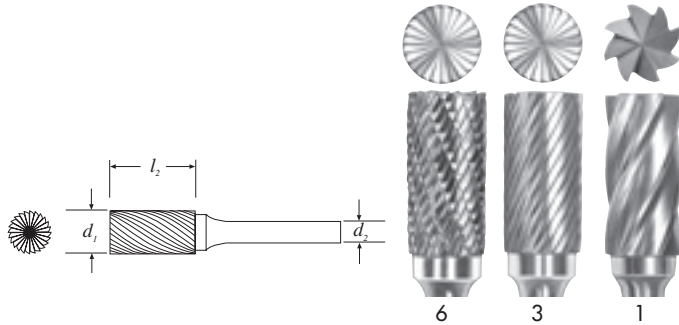

| Tool No. | Cutter Diameter d_1 | Length of Cut l_2 | Shank Diameter d_2 | Double Cut EDP No. | Single Cut EDP No. | Nonferrous Cut EDP No. |
|-----------|--------------------------|------------------------|-------------------------|-----------------------|-----------------------|---------------------------|
| SB-41 | 1/16 | 1/4 | 1/8 | 11453 | 11450 | |
| SB-41L2 | 1/16 | 1/4 | 1/8 | 17253 | 17250 | |
| SB-41L3 | 1/16 | 1/4 | 1/8 | 17278 | 17275 | |
| SB-42 | 3/32 | 7/16 | 1/8 | 11478 | 11475 | |
| SB-42L2 | 3/32 | 7/16 | 1/8 | 17303 | 17300 | |
| SB-42L3 | 3/32 | 7/16 | 1/8 | 17328 | 17325 | |
| SB-ECO | 1/8 | | 1/8 | | 11525 | |
| SB-11 | 1/8 | 1/2 | 1/4 | 11253 | 11250 | |
| SB-12 | 1/8 | 5/8 | 1/4 | 11278 | 11275 | |
| SB-43 | 1/8 | 9/16 | 1/8 | 11503 | 11500 | |
| SB-43L2 | 1/8 | 9/16 | 1/8 | 17353 | 17350 | |
| SB-43L3 | 1/8 | 9/16 | 1/8 | 17378 | 17375 | |
| SB-13 | 5/32 | 5/8 | 1/4 | 11303 | 11300 | |
| SB-14 | 3/16 | 5/8 | 1/4 | 10328 | 10825 | |
| SB-51 | 1/4 | 3/16 | 1/8 | 11553 | 11550 | |
| SB-1 | 1/4 | 5/8 | 1/4 | 10853 | 10850 | |
| SB-1L | 1/4 | 1 | 1/4 | 10878 | 10875 | |
| SB-1NF | 1/4 | 3/4 | 1/4 | | | 19012 |
| SB-2 | 5/16 | 3/4 | 1/4 | 10903 | 10900 | |
| SB-3 | 3/8 | 3/4 | 1/4 | 10928 | 10925 | |
| SB-3L | 3/8 | 1 | 1/4 | 10953 | 10950 | |
| SB-3NF | 3/8 | 3/4 | 1/4 | | | 19014 |
| SB-3X | 3/8 | 1-1/2 | 1/4 | 10978 | 10975 | |
| SB-4 | 7/16 | 1 | 1/4 | 11003 | 11000 | |
| SB-5 | 1/2 | 1 | 1/4 | 11028 | 11025 | |
| SB-5NF | 1/2 | 1 | 1/4 | | | 19016 |
| * SB-6 | 5/8 | 1 | 1/4 | 11053 | 11050 | |
| * SB-6NF | 5/8 | 1 | 1/4 | | | 19018 |
| * SB-15 | 3/4 | 1/2 | 1/4 | 11353 | 11350 | |
| * SB-16 | 3/4 | 3/4 | 1/4 | 11403 | 11400 | |
| * SB-7 | 3/4 | 1 | 1/4 | 11103 | 11100 | |
| SB-7NF | 3/4 | 1 | 1/4 | | | 19020 |
| SB-7NF3/8 | 3/4 | 1 | 3/8 | | | 19022 |
| * SB-8 | 7/8 | 1 | 1/4 | 11153 | 11150 | |
| * SB-9 | 1 | 1 | 1/4 | 11203 | 11200 | |

E

**Cylinder Shape Burs with End Cut
Solid Carbide**

* 3/8" shanks optional
To Order Optional Cuts 4, 3SP, 2, 5 – Specify Quantity, Tool No. & Optional Cut.
- Complete Bur Regrind Service Available

ES

**Limas rotativas en forma cilíndrica
con corte frontal**

Carburo sólido
* Zanco de 3/8" opcional.
Para ordenar cortes opcionales 4, 3SP, 2, y 5 :
Especifique la cantidad, no. de herramienta y tipo de corte opcional.
- Disponemos de un servicio completo de reafileado de limas rotativas

FR

**Fraises-limes de forme cylindrique avec
denture en bout**

Carbure monobloc
* Queue de 3/8" en option.
Pour commander les coupes en option 4, 3SP, 2, 5 :
indiquer la quantité, le N° d'outil et la coupe.
- Service de réaffûtage complet de fraises rotatives disponible

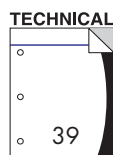
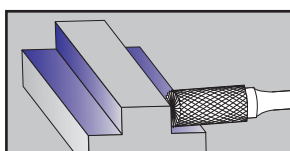
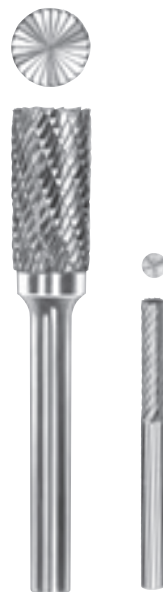

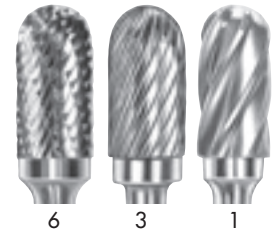
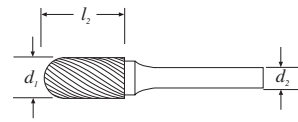

E

**Cylinder Shape Burs with Radius End
Solid Carbide**

* 3/8" shanks optional
To Order Optional Cuts 4, 3SP, 2, 5 – Specify Quantity, Tool No. & Optional Cut.
- Complete Bur Regrind Service Available.

ES

**Limas rotativas en forma cilíndrica
con radio**

Carburo sólido
* Zanco de 3/8" opcional.
Para ordenar cortes opcionales 4, 3SP, 2, y 5 :
Especifique la cantidad, no. de herramienta y
tipo de corte opcional.
- Disponemos de un servicio completo de reaflado de limas rotativas

FR

**Fraises-limes de forme cylindrique à
bout hémisphérique**

Carbure monobloc
* Queue de 3/8" en option.
Pour commander les coupes en option 4, 3SP, 2,
5 : indiquer la quantité, le N° d'outil et la coupe.
- Service de réaffûtage complet de fraises rotatives disponible

| Tool No. | Cutter Diameter d ₁ | Length of Cut l ₂ | Shank Diameter d ₂ | Double Cut EDP No. | Single Cut EDP No. | Nonferrous Cut EDP No. |
|-----------|--------------------------------|------------------------------|-------------------------------|--------------------|--------------------|------------------------|
| SC-61 | 3/32 | 3/8 | 3/32 | 12378 | 12375 | |
| SC-41 | 3/32 | 7/16 | 1/8 | 12253 | 12250 | |
| SC-11 | 1/8 | 1/2 | 1/4 | 12053 | 12050 | |
| SC-42 | 1/8 | 9/16 | 1/8 | 12278 | 12275 | |
| SC-42L2 | 1/8 | 9/16 | 1/8 | 17453 | 17450 | |
| SC-42L3 | 1/8 | 9/16 | 1/8 | 17478 | 17475 | |
| SC-12 | 1/8 | 5/8 | 1/4 | 12078 | 12075 | |
| SC-52 | 5/32 | 1/2 | 1/8 | 12328 | 12325 | |
| SC-13 | 5/32 | 5/8 | 1/4 | 12103 | 12100 | |
| SC-81 | 3/16 | 5/8 | 3/16 | 12403 | 12400 | |
| SC-53 | 3/16 | 1/2 | 1/8 | 12353 | 12350 | |
| SC-14 | 3/16 | 5/8 | 1/4 | 12128 | 12125 | |
| SC-51 | 1/4 | 1/2 | 1/8 | 12303 | 12300 | |
| SC-1 | 1/4 | 5/8 | 1/4 | 11703 | 11700 | |
| SC-1L | 1/4 | 1 | 1/4 | 11728 | 11725 | |
| SC-1L6 | 1/4 | 1/2 | 1/4 | 16328 | 16325 | |
| SC-1NF | 1/4 | 3/4 | 1/4 | | | 19024 |
| SC-2 | 5/16 | 3/4 | 1/4 | 11753 | 11750 | |
| SC-3 | 3/8 | 3/4 | 1/4 | 11778 | 11775 | |
| SC-3L | 3/8 | 1 | 1/4 | 11803 | 11800 | |
| SC-3L6 | 3/8 | 3/4 | 1/4 | 16353 | 16350 | |
| SC-3NF | 3/8 | 3/4 | 1/4 | | | 19026 |
| SC-3X | 3/8 | 1-1/2 | 1/4 | 11828 | 11825 | |
| SC-4 | 7/16 | 1 | 1/4 | 11853 | 11850 | |
| SC-5 | 1/2 | 1 | 1/4 | 11878 | 11875 | |
| SC-5L6 | 1/2 | 1 | 1/4 | 16378 | 16375 | |
| SC-5NF | 1/2 | 1 | 1/4 | | | 19028 |
| * SC-6 | 5/8 | 1 | 1/4 | 11903 | 11900 | |
| * SC-6NF | 5/8 | 1 | 1/4 | | | 19030 |
| * SC-15 | 3/4 | 1/2 | 1/4 | 12153 | 12150 | |
| * SC-16 | 3/4 | 3/4 | 1/4 | 12203 | 12200 | |
| * SC-7 | 3/4 | 1 | 1/4 | 11953 | 11950 | |
| SC-7NF | 3/4 | 1 | 1/4 | | | 19032 |
| SC-7NF3/8 | 3/4 | 1 | 3/8 | | | 19034 |
| * SC-9 | 1 | 1 | 1/4 | 12003 | 12000 | |

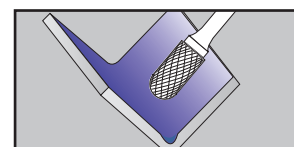
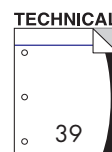

SD Burs - Ball Shape - Fractional

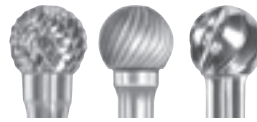
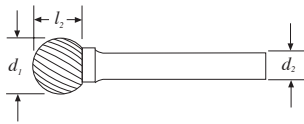

| Tool No. | Cutter Diameter d_1 | Length of Cut l_2 | Shank Diameter d_2 | 6 | | 3 | | 1 | |
|-------------|--------------------------|------------------------|-------------------------|-----------------------|-----------------------|-----------------------|-----------------------|---------------------------|---------------------------|
| | | | | Double Cut EDP No. | Single Cut EDP No. | Double Cut EDP No. | Single Cut EDP No. | Nonferrous Cut EDP No. | Nonferrous Cut EDP No. |
| SD-41 | 3/32 | 3/32 | 1/8 | 12778 | 12775 | | | | |
| SD-61 | 3/32 | 3/32 | 3/32 | 12878 | 12875 | | | | |
| SD-11 | 1/8 | 3/32 | 1/4 | 12728 | 12725 | | | | |
| SD-42 | 1/8 | 1/8 | 1/8 | 12803 | 12800 | | | | |
| SD-42L2 | 1/8 | 1/8 | 1/8 | 17553 | 17550 | | | | |
| SD-42L3 | 1/8 | 1/8 | 1/8 | 17578 | 17575 | | | | |
| SD-52 | 5/32 | 5/32 | 1/8 | 12840 | 12837 | | | | |
| SD-14 | 3/16 | 1/8 | 1/4 | 12753 | 12750 | | | | |
| SD-81 | 3/16 | 5/32 | 3/16 | 12903 | 12900 | | | | |
| SD-53 | 3/16 | 5/32 | 1/8 | 12853 | 12850 | | | | |
| SD-1 | 1/4 | 7/32 | 1/4 | 12453 | 12450 | | | | |
| SD-1L6 | 1/4 | 7/32 | 1/4 | 16403 | 16400 | | | | |
| SD-1NF | 1/4 | 7/32 | 1/4 | | | | | | 19036 |
| SD-51 | 1/4 | 7/32 | 1/8 | 12828 | 12825 | | | | |
| SD-2 | 5/16 | 1/4 | 1/4 | 12478 | 12475 | | | | |
| SD-3 | 3/8 | 5/16 | 1/4 | 12503 | 12500 | | | | |
| SD-3L6 | 3/8 | 5/16 | 1/4 | 16428 | 16425 | | | | |
| SD-3NF | 3/8 | 5/16 | 1/4 | | | | | | 19038 |
| SD-4 | 7/16 | 3/8 | 1/4 | 12528 | 12525 | | | | |
| SD-5 | 1/2 | 7/16 | 1/4 | 12553 | 12550 | | | | |
| SD-5L6 | 1/2 | 7/16 | 1/4 | 16453 | 16450 | | | | |
| SD-5NF | 1/2 | 7/16 | 1/4 | | | | | | 19040 |
| * SD-6 | 5/8 | 9/16 | 1/4 | 12578 | 12575 | | | | |
| * SD-6NF | 5/8 | 9/16 | 1/4 | | | | | | 19042 |
| SD-7 | 3/4 | 11/16 | 1/4 | 12628 | 12625 | | | | |
| SD-7NF | 3/4 | 11/16 | 1/4 | | | | | | 19044 |
| * SD-7NF3/8 | 3/4 | 11/16 | 3/8 | | | | | | 19046 |
| SD-9 | 1 | 15/16 | 1/4 | 12678 | 12675 | | | | |

E

Ball Shape Burs

Solid Carbide

* 3/8" shanks optional

To Order Optional Cuts 4, 3SP, 2, 5 – Specify Quantity, Tool No. & Optional Cut.

- Complete Bur Regrind Services Available

ES

Limas rotativas esféricas

Carburo sólido

* Zanco de 3/8" opcional.

Para ordenar cortes opcionales 4, 3SP, 2, y 5 : Especifique la cantidad, no. de herramienta y tipo de corte opcional.

- Disponemos de un servicio completo de reaflado de limas rotativas

FR

Fraises-limes de forme sphérique

Carbure monobloc

* Queue de 3/8" en option.

Pour commander les coupes en option 4, 3SP, 2, 5 : indiquer la quantité, le N° d'outil et la coupe.

- Service de réaffûtage complet de fraises rotatives disponible

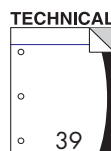
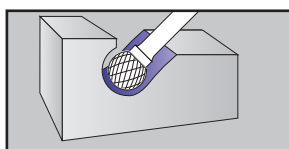

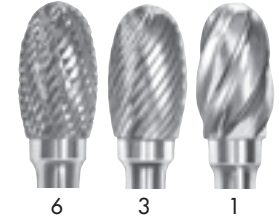
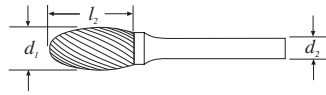

E

Oval Shape Burs

Solid Carbide

* 3/8" shanks optional

To Order Optional Cuts 4, 3SP, 2, 5 – Specify Quantity, Tool No. & Optional Cut

- Complete Bur Regrind Service Available

ES

Limas rotativas en forma ovalada

Carburo sólido

* Zanco de 3/8" opcional.

Para ordenar cortes opcionales 4, 3SP, 2, y 5 :

Especifique la cantidad, no. de herramienta y tipo de corte opcional.

- Disponemos de un servicio completo de reafileado de limas rotativas

FR

Fraises-limes de forme ovale

Carbure monobloc

* Queue de 3/8" en option.

Pour commander les coupes en option 4, 3SP, 2, 5 : indiquer la quantité, le N° d'outil et la coupe.

- Service de réaffûtage complet de fraises rotatives disponible

| Tool No. | Cutter Diameter d_1 | Length of Cut l_2 | Shank Diameter d_2 | Double Cut EDP No. | Single Cut EDP No. | Nonferrous Cut EDP No. |
|-----------|--------------------------|------------------------|-------------------------|-----------------------|-----------------------|---------------------------|
| SE-61 | 3/32 | 1/8 | 3/32 | 13228 | 13225 | |
| SE-41 | 1/8 | 7/32 | 1/8 | 13153 | 13150 | |
| SE-41L2 | 1/8 | 7/32 | 1/8 | 17603 | 17600 | |
| SE-41L3 | 1/8 | 7/32 | 1/8 | 17628 | 17625 | |
| SE-81 | 3/16 | 9/32 | 3/16 | 13253 | 13250 | |
| SE-53 | 3/16 | 9/32 | 1/8 | 13203 | 13200 | |
| SE-11 | 3/16 | 5/16 | 1/4 | 13128 | 13125 | |
| SE-1 | 1/4 | 3/8 | 1/4 | 12953 | 12950 | |
| SE-1L6 | 1/4 | 3/8 | 1/4 | 16478 | 16475 | |
| SE-51 | 1/4 | 3/8 | 1/8 | 13178 | 13175 | |
| SE-3 | 3/8 | 5/8 | 1/4 | 12978 | 12975 | |
| SE-3L6 | 3/8 | 5/8 | 1/4 | 16503 | 16500 | |
| SE-3NF | 3/8 | 5/8 | 1/4 | | | 19048 |
| SE-5 | 1/2 | 7/8 | 1/4 | 13003 | 13000 | |
| SE-5L6 | 1/2 | 7/8 | 1/4 | 16528 | 16525 | |
| SE-5NF | 1/2 | 7/8 | 1/4 | | | 19050 |
| * SE-6 | 5/8 | 1 | 1/4 | 13028 | 13025 | |
| * SE-6NF | 5/8 | 1 | 1/4 | | | 19052 |
| * SE-7 | 3/4 | 1 | 1/4 | 13078 | 13075 | |
| SE-7NF | 3/4 | 1 | 1/4 | | | 19054 |
| SE-7NF3/8 | 3/4 | 1 | 3/8 | | | 19056 |

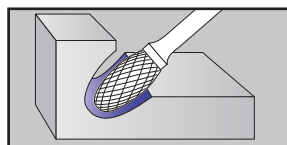
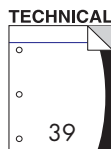

SF Burs - Tree Shape - Fractional

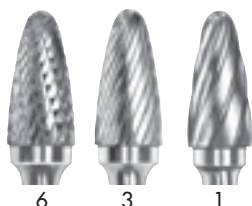
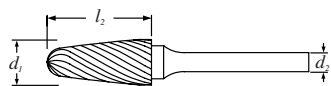

| Tool No. | Cutter Diameter d_1 | Length of Cut l_2 | Shank Diameter d_2 | Double Cut EDP No. | Single Cut EDP No. | Nonferrous Cut EDP No. |
|------------|--------------------------|------------------------|-------------------------|-----------------------|-----------------------|---------------------------|
| SF-61 | 3/32 | 1/4 | 3/32 | 13778 | 13775 | |
| SF-41 | 1/8 | 1/4 | 1/8 | 13678 | 13675 | |
| SF-11 | 1/8 | 1/2 | 1/4 | 13503 | 13500 | |
| SF-42 | 1/8 | 1/2 | 1/8 | 13703 | 13700 | |
| SF-42L2 | 1/8 | 1/2 | 1/8 | 17653 | 17650 | |
| SF-42L3 | 1/8 | 1/2 | 1/8 | 17678 | 17675 | |
| SF-81 | 3/16 | 1/2 | 3/16 | 13803 | 13800 | |
| SF-53 | 3/16 | 1/2 | 1/8 | 13753 | 13750 | |
| SF-51 | 1/4 | 1/2 | 1/8 | 13728 | 13725 | |
| SF-1 | 1/4 | 3/4 | 1/4 | 13303 | 13300 | |
| SF-1L6 | 1/4 | 1/2 | 1/4 | 16553 | 16550 | |
| SF-1NF | 1/4 | 3/4 | 1/4 | | | 19058 |
| SF-3 | 3/8 | 3/4 | 1/4 | 13328 | 13325 | |
| SF-3L6 | 3/8 | 3/4 | 1/4 | 16578 | 16575 | |
| SF-3NF | 3/8 | 3/4 | 1/4 | | | 19060 |
| SF-4 | 7/16 | 1 | 1/4 | 13353 | 13350 | |
| SF-13 | 1/2 | 3/4 | 1/4 | 13528 | 13525 | |
| SF-5 | 1/2 | 1 | 1/4 | 13378 | 13375 | |
| SF-5L6 | 1/2 | 1 | 1/4 | 16603 | 16600 | |
| SF-5NF | 1/2 | 1 | 1/4 | | | 19062 |
| * SF-6 | 5/8 | 1 | 1/4 | 13403 | 13400 | |
| * SF-6NF | 5/8 | 1 | 1/4 | | | 19064 |
| * SF-7 | 3/4 | 1 | 1/4 | 13453 | 13450 | |
| * SF-14 | 3/4 | 1-1/4 | 1/4 | 13578 | 13575 | |
| SF-14NF | 3/4 | 1-1/4 | 1/4 | | | 19066 |
| SF-14NF3/8 | 3/4 | 1-1/4 | 3/8 | | 19068 | |
| * SF-15 | 3/4 | 1-1/2 | 1/4 | 13628 | 13625 | |

E

Tree Shape Burs with Radius End Solid Carbide

* 3/8" shanks optional

To Order Optional Cuts 4, 3SP, 2, 5 – Specify Quantity, Tool No. & Optional Cut

- Complete Bur Regrind Service Available

ES

Limas rotativas en forma de árbol Carburo sólido

* Zanco de 3/8" opcional.

Para ordenar cortes opcionales 4, 3SP, 2, y 5 :

Especifique la cantidad, no. de herramienta y tipo de corte opcional.

- Disponemos de un servicio completo de reafilado de limas rotativas

FR

Fraises-limes en forme d'ogive à bout hémisphérique

Carbure monobloc

* Queue de 3/8" en option.

Pour commander les coupes en option 4, 3SP, 2, 5 : indiquer la quantité, le N° d'outil et la coupe.

- Service de réaffûtage complet de fraises rotatives disponible

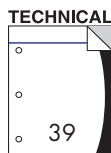
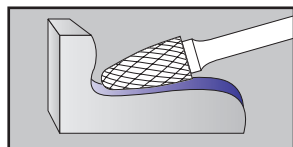

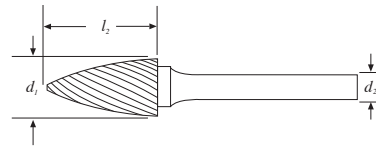

E

**Tree Shape Burs with Pointed End
Solid Carbide**

* 3/8" shanks optional

To Order Optional Cuts 4, 3SP, 2, 5 – Specify Quantity, Tool No. & Optional Cut.

- Complete Bur Regrind Service Available

ES

**Limas rotativas en forma de árbol
puntiagudo Carburo sólido**

* Zanco de 3/8" opcional.

Para ordenar cortes opcionales 4, 3SP, 2, y 5 :
Especifique la cantidad, no. de herramienta
y tipo de corte opcional.

- Disponemos de un servicio completo de
reafilado de limas rotativas

FR

**Fraises-limes en forme d'ogive à
bout pointu**

Carbure monobloc

* Queue de 3/8" en option.

Pour commander les coupes en option 4, 3SP, 2,
5 : indiquer la quantité, le N° d'outil et la coupe.

- Service de réaffûtage complet de fraises rota-
tives disponible

| Tool No. | Cutter Diameter d_1 | Length of Cut l_2 | Shank Diameter d_2 | Double Cut EDP No. | Single Cut EDP No. |
|----------|--------------------------|------------------------|-------------------------|-----------------------|-----------------------|
| SG-61 | 3/32 | 1/4 | 3/32 | 14303 | 14300 |
| SG-41 | 1/8 | 1/4 | 1/8 | 14153 | 14150 |
| SG-42 | 1/8 | 5/16 | 1/8 | 14178 | 14175 |
| SG-43 | 1/8 | 3/8 | 1/8 | 14203 | 14200 |
| SG-44 | 1/8 | 1/2 | 1/8 | 14228 | 14225 |
| SG-44L2 | 1/8 | 1/2 | 1/8 | 17853 | 17850 |
| SG-44L3 | 1/8 | 1/2 | 1/8 | 17878 | 17875 |
| SG-81 | 3/16 | 1/2 | 3/16 | 14328 | 14325 |
| SG-53 | 3/16 | 1/2 | 1/8 | 14278 | 14275 |
| SG-1 | 1/4 | 5/8 | 1/4 | 13853 | 13850 |
| SG-1L6 | 1/4 | 1/2 | 1/4 | 16628 | 16625 |
| SG-51 | 1/4 | 1/2 | 1/8 | 14253 | 14250 |
| SG-2 | 5/16 | 3/4 | 1/4 | 13878 | 13875 |
| SG-3 | 3/8 | 3/4 | 1/4 | 13903 | 13900 |
| SG-3L6 | 3/8 | 3/4 | 1/4 | 16653 | 16650 |
| SG-13 | 1/2 | 3/4 | 1/4 | 14053 | 14050 |
| SG-5 | 1/2 | 1 | 1/4 | 13928 | 13925 |
| SG-5L6 | 1/2 | 1 | 1/4 | 16678 | 16675 |
| * SG-6 | 5/8 | 1 | 1/4 | 13953 | 13950 |
| * SG-7 | 3/4 | 1 | 1/4 | 14003 | 14000 |
| * SG-15 | 3/4 | 1-1/2 | 1/4 | 14103 | 14100 |

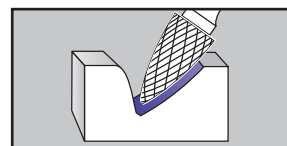

SH Burs - Flame Shape - Fractional

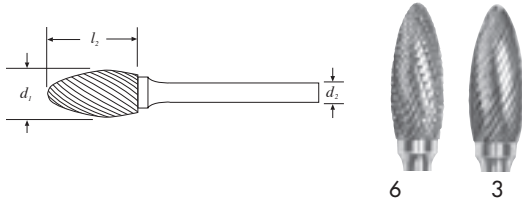

| Tool No. | Cutter Diameter d_1 | Length of Cut l_2 | Shank Diameter d_2 | 6 Double Cut EDP No. | 3 Single Cut EDP No. |
|----------|--------------------------|------------------------|-------------------------|----------------------------|----------------------------|
| SH-41 | 1/8 | 1/4 | 1/8 | 14553 | 14550 |
| SH-41L2 | 1/8 | 1/4 | 1/8 | 17903 | 17900 |
| SH-41L3 | 1/8 | 1/4 | 1/8 | 17928 | 17925 |
| SH-53 | 3/16 | 3/8 | 1/8 | 14603 | 14600 |
| SH-1 | 1/4 | 5/8 | 1/4 | 14378 | 14375 |
| SH-2 | 5/16 | 3/4 | 1/4 | 14403 | 14400 |
| SH-2L6 | 5/16 | 3/4 | 1/4 | 16703 | 16700 |
| SH-5 | 1/2 | 1-1/4 | 1/4 | 14428 | 14425 |
| SH-5L6 | 1/2 | 1-1/4 | 1/4 | 16728 | 16725 |
| * SH-6 | 5/8 | 1-7/16 | 1/4 | 14453 | 14450 |
| * SH-7 | 3/4 | 1-5/8 | 1/4 | 14503 | 14500 |

E

Flame Shape Burs Solid Carbide

* 3/8" shanks optional
To Order Optional Cuts 4, 3SP, 2, 5
Specify Quantity, Tool No. & Optional cut
- Complete Bur Regrind service Available

ES

Limas rotativas en forma de llama Carburo sólido

* Zanco de 3/8" opcional.
Para ordenar cortes opcionales 4, 3SP, 2,
y 5 : Especifique la cantidad, no. de
herramienta y tipo de corte opcional.
- Disponemos de un servicio completo
de reafilado de limas rotativas

FR

Fraises-limes en forme de flamme Carbure monobloc

* Queue de 3/8" en option.
Pour commander les coupes en option
4, 3SP, 2, 5 : indiquer la quantité, le
N° d'outil et la coupe.
- Service de réaffûtage complet
de fraisesrotatives disponible

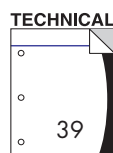
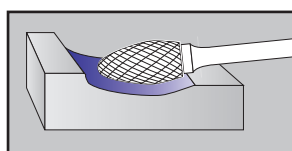

Burs - Cone Shape - 60° & 90° - Fractional **SJ, SK**

SJ



E

SJ - 60° Cone Shape Burs
SK - 90° Cone Shape Burs
Solid Carbide

* 3/8" shanks optional
To Order Optional Cuts 4, 3SP, 2, 5 – Specify Quantity, Tool No. & Optional Cut.
- Complete Bur Regrind Service Available

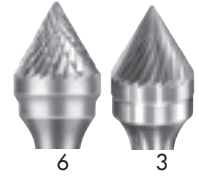
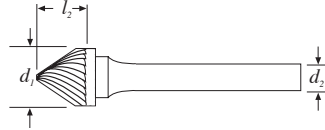

| Tool No. | Cutter Diameter d_1 | Length of Cut l_2 | Shank Diameter d_2 | Double Cut EDP No. | Single Cut EDP No. |
|----------|--------------------------|------------------------|-------------------------|-----------------------|-----------------------|
| SJ-42 | 1/8 | 3/32 | 1/8 | 14903 | 14900 |
| SJ-1 | 1/4 | 3/16 | 1/4 | 14678 | 14675 |
| SJ-3 | 3/8 | 5/16 | 1/4 | 14703 | 14700 |
| SJ-5 | 1/2 | 7/16 | 1/4 | 14728 | 14725 |
| * SJ-6 | 5/8 | 9/16 | 1/4 | 14753 | 14750 |
| * SJ-7 | 3/4 | 11/16 | 1/4 | 14803 | 14800 |
| * SJ-9 | 1 | 15/16 | 1/4 | 14853 | 14850 |

ES

Limas rotativas cónica
Carburo sólido

SJ - Forma cónica a 60°
SK - Forma cónica a 90°

* Zanco de 3/8" opcional.
Para ordenar cortes opcionales 4, 3SP, 2, y 5 :
Especifique la cantidad, no. de herramienta y tipo de corte opcional.
- Disponemos de un servicio completo de reafilado de limas rotativas

SK



FR

Fraises-limes de forme conique, à 60° et 90° Carbure monobloc

SJ - Forme conique, 60°
SK - Forme conique, 90°

* Queue de 3/8" en option.
Pour commander les coupes en option 4, 3SP, 2, 5 :
indiquer la quantité, le N° d'outil et la coupe.
- Service de réaffûtage complet de fraises rotatives disponible

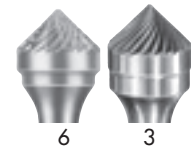
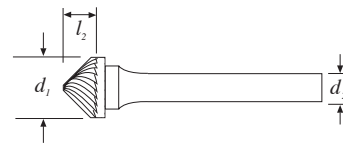

| Tool No. | Cutter Diameter d_1 | Length of Cut l_2 | Shank Diameter d_2 | Double Cut EDP No. | Single Cut EDP No. |
|----------|--------------------------|------------------------|-------------------------|-----------------------|-----------------------|
| SK-42 | 1/8 | 1/16 | 1/8 | 15153 | 15150 |
| SK-1 | 1/4 | 1/8 | 1/4 | 14928 | 14925 |
| SK-3 | 3/8 | 3/16 | 1/4 | 14953 | 14950 |
| SK-5 | 1/2 | 1/4 | 1/4 | 14978 | 14975 |
| * SK-6 | 5/8 | 5/16 | 1/4 | 15003 | 15000 |
| * SK-7 | 3/4 | 3/8 | 1/4 | 15053 | 15050 |
| * SK-9 | 1 | 1/2 | 1/4 | 15103 | 15100 |

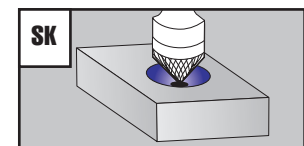
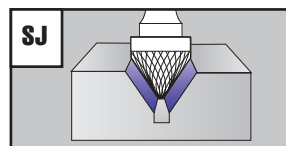
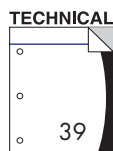

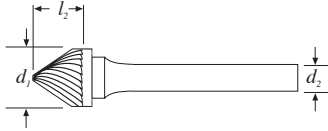

| Tool No. | Cutter Diameter d ₁ | Length of Cut l ₂ | Shank Diameter d ₂ | Included Angle α | 6 | 3 | 1 |
|-----------|-----------------------------------|---------------------------------|----------------------------------|---------------------|-----------------------|-----------------------|---------------------------|
| | | | | | Double Cut EDP No. | Single Cut EDP No. | Nonferrous Cut EDP No. |
| SL-41 | 1/8 | 3/8 | 1/8 | 8° | 15403 | 15400 | |
| SL-42 | 1/8 | 1/2 | 1/8 | 8° | 15428 | 15425 | |
| SL-42L2 | 1/8 | 1/2 | 1/8 | 8° | 17953 | 17950 | |
| SL-42L3 | 1/8 | 1/2 | 1/8 | 8° | 17978 | 17975 | |
| SL-81 | 3/16 | 7/16 | 3/16 | 14° | 15478 | 15475 | |
| SL-53 | 3/16 | 1/2 | 1/8 | 14° | 15453 | 15450 | |
| SL-1 | 1/4 | 5/8 | 1/4 | 14° | 15178 | 15175 | |
| SL-1L6 | 1/4 | 5/8 | 1/4 | 14° | 16753 | 16750 | |
| SL-2 | 5/16 | 7/8 | 1/4 | 14° | 15203 | 15200 | |
| SL-3 | 3/8 | 1-1/16 | 1/4 | 14° | 15228 | 15225 | |
| SL-3L6 | 3/8 | 1-1/16 | 1/4 | 14° | 16778 | 16775 | |
| SL-3NF | 3/8 | 1-1/16 | 1/4 | 14° | | | 19070 |
| SL-4 | 1/2 | 1-1/8 | 1/4 | 14° | 15253 | 15250 | |
| SL-4L6 | 1/2 | 1-1/8 | 1/4 | 14° | 16803 | 16800 | |
| SL-4NF | 1/2 | 1-1/8 | 1/4 | 14° | | | 19072 |
| *SL-5 | 5/8 | 1-3/16 | 1/4 | 14° | 15278 | 15275 | |
| *SL-5NF | 5/8 | 1-3/16 | 1/4 | 14° | | | 19074 |
| *SL-6 | 5/8 | 1-5/16 | 1/4 | 14° | 15303 | 15300 | |
| *SL-6NF | 5/8 | 1-5/16 | 1/4 | 14° | | | 19076 |
| *SL-7 | 3/4 | 1-1/2 | 1/4 | 14° | 15353 | 15350 | |
| SL-7NF | 3/4 | 1-1/2 | 1/4 | 14° | | | 19078 |
| SL-7NF3/8 | 3/4 | 1-1/2 | 3/8 | 14° | | | 19080 |

E

Taper with Radius End Burs

Solid Carbide

* 3/8" shanks optional.

To Order Optional Cuts 4, 3SP, 2, 5
Specify Quantity, Tool No.

& Optional Cut

- Complete Bur Regrind Service Available

ES

Limas rotativas cónicas con radio en la punta

Carburo sólido

* Zanco de 3/8" opcional.

Para ordenar cortes opcionales 4, 3SP, 2, y 5 : Especifique la cantidad, no. de herramienta y tipo de corte opcional.

- Disponemos de un servicio completo de reafileado de limas rotativas

FR

Fraises-limes de forme conique, à bout hémisphérique

Carbure monobloc

* Queue de 3/8" en option.

Pour commander les coupes en option 4, 3SP, 2, 5 : indiquer la quantité, le N° d'outil et la coupe.

- Service de réaffûtage complet de fraises rotatives disponible

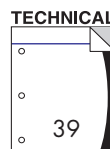
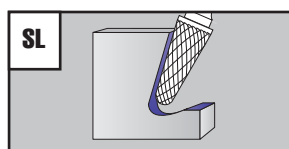

SM

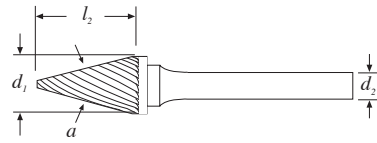

6

3

E

Cone (SM) and Inverted Cone (SN) Shape Burs

Solid Carbide

* 3/8" shanks optional.

To Order Optional Cuts 4, 3SP, 2, 5 - Specify Quantity, Tool No. & Optional Cut.

- Complete Bur Regrind Service Available

ES

Limas rotativas (SM) cónicas (SN) cónica invertida

Carburo sólido

* Zanco de 3/8" opcional.

Para ordenar cortes opcionales 4, 3SP, 2, y 5 : Especifique la cantidad, no. de herramienta y tipo de corte opcional.

- Disponemos de un servicio completo de reafileado de limas rotativas

| Tool No. | Cutter Diameter d_1 | Length of Cut l_2 | Shank Diameter d_2 | Included Angle a | Double Cut EDP No. | Single Cut EDP No. |
|----------|--------------------------|------------------------|-------------------------|-----------------------|-----------------------|-----------------------|
| SM-61 | 3/32 | 1/4 | 3/32 | 10° | 15803 | 15800 |
| SM-41 | 1/8 | 11/32 | 1/8 | 12° | 15678 | 15675 |
| SM-42 | 1/8 | 7/16 | 1/8 | 14° | 15703 | 15700 |
| SM-42L2 | 1/8 | 7/16 | 1/8 | 14° | 18053 | 18050 |
| SM-42L3 | 1/8 | 7/16 | 1/8 | 14° | 18078 | 18075 |
| SM-43 | 1/8 | 5/8 | 1/8 | 7° | 15728 | 15725 |
| SM-53 | 3/16 | 1/2 | 1/8 | 16° | 15778 | 15775 |
| SM-1 | 1/4 | 1/2 | 1/4 | 22° | 15503 | 15500 |
| SM-51 | 1/4 | 1/2 | 1/8 | 22° | 15753 | 15750 |
| SM-2 | 1/4 | 3/4 | 1/4 | 14° | 15528 | 15525 |
| SM-3 | 1/4 | 1 | 1/4 | 10° | 15553 | 15550 |
| SM-4 | 3/8 | 5/8 | 1/4 | 28° | 15578 | 15575 |
| SM-5 | 1/2 | 7/8 | 1/4 | 28° | 15603 | 15600 |
| * SM-6 | 5/8 | 1 | 1/4 | 31° | 15628 | 15625 |

SN

FR

Fraises-limes (SM) de forme conique et conique inversée (SN)

Carbure monobloc

* Queue de 3/8" en option.

Pour commander les coupes en option 4, 3SP, 2, 5: indiquer la quantité, le N° d'outil et la coupe.

- Service de réaffûtage complet de fraises rotatives disponible

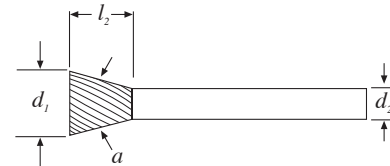

6

3



| Tool No. | Cutter Diameter d_1 | Length of Cut l_2 | Shank Diameter d_2 | Included Angle a | Double Cut EDP No. | Single Cut EDP No. |
|----------|--------------------------|------------------------|-------------------------|-----------------------|-----------------------|-----------------------|
| SN-41 | 3/32 | 1/8 | 1/8 | 10° | 16028 | 16025 |
| SN-61 | 3/32 | 1/8 | 3/32 | 10° | 16128 | 16125 |
| SN-42 | 1/8 | 3/16 | 1/8 | 10° | 16053 | 16050 |
| SN-81 | 3/16 | 1/4 | 3/16 | 10° | 16153 | 16150 |
| SN-53 | 3/16 | 1/4 | 1/8 | 10° | 16103 | 16100 |
| SN-51 | 1/4 | 1/4 | 1/8 | 10° | 16078 | 16075 |
| SN-1 | 1/4 | 5/16 | 1/4 | 10° | 15853 | 15850 |
| SN-2 | 3/8 | 3/8 | 1/4 | 13° | 15878 | 15875 |
| SN-4 | 1/2 | 1/2 | 1/4 | 28° | 15903 | 15900 |
| * SN-6 | 5/8 | 3/4 | 1/4 | 18° | 15928 | 15925 |
| * SN-7 | 3/4 | 5/8 | 1/4 | 30° | 15978 | 15975 |

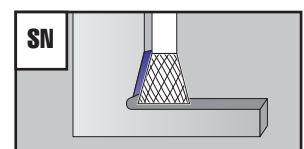
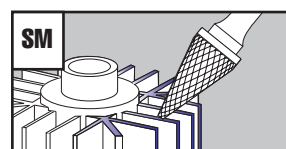
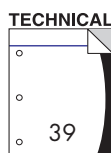

Burs - Long Shank - Fractional

Limas rotativas con zanco largo • Fraises-limes à queue longue

Burs listed are provided with 6" long steel shanks

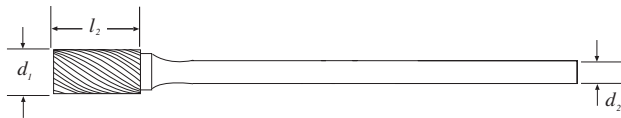

Cylinder Shape
Forma cilíndrica
Forme cylindrique

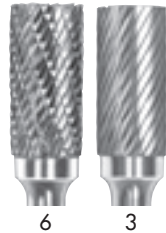

| Tool No. | Cutter Diameter d_1 | Length of Cut l_2 | Shank Diameter d_2 | Double Cut EDP No. | Single Cut EDP No. |
|----------|--------------------------|------------------------|-------------------------|-----------------------|-----------------------|
| SA-1L6 | 1/4 | 1/2 | 1/4 | 16178 | 16175 |
| SA-3L6 | 3/8 | 3/4 | 1/4 | 16203 | 16200 |
| SA-5L6 | 1/2 | 1 | 1/4 | 16228 | 16225 |

Cylinder Shape Radius End
Forma cilíndrica Con radio
Forme cylindrique À bout hémisphérique



| Tool No. | Cutter Diameter d_1 | Length of Cut l_2 | Shank Diameter d_2 | Double Cut EDP No. | Single Cut EDP No. |
|----------|--------------------------|------------------------|-------------------------|-----------------------|-----------------------|
| SC-1L6 | 1/4 | 1/2 | 1/4 | 16328 | 16325 |
| SC-3L6 | 3/8 | 3/4 | 1/4 | 16353 | 16350 |
| SC-5L6 | 1/2 | 1 | 1/4 | 16378 | 16375 |

Ball Shape
Forma esférica
Forme sphérique

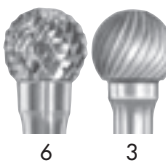

| Tool No. | Cutter Diameter d_1 | Length of Cut l_2 | Shank Diameter d_2 | Double Cut EDP No. | Single Cut EDP No. |
|----------|--------------------------|------------------------|-------------------------|-----------------------|-----------------------|
| SD-1L6 | 1/4 | 7/32 | 1/4 | 16403 | 16400 |
| SD-3L6 | 3/8 | 5/16 | 1/4 | 16428 | 16425 |
| SD-5L6 | 1/2 | 7/16 | 1/4 | 16453 | 16450 |

Oval Shape
Forma ovalada
Forme ovale



| Tool No. | Cutter Diameter d_1 | Length of Cut l_2 | Shank Diameter d_2 | Double Cut EDP No. | Single Cut EDP No. |
|----------|--------------------------|------------------------|-------------------------|-----------------------|-----------------------|
| SE-1L6 | 1/4 | 3/8 | 1/4 | 16478 | 16475 |
| SE-3L6 | 3/8 | 5/8 | 1/4 | 16503 | 16500 |
| SE-5L6 | 1/2 | 7/8 | 1/4 | 16528 | 16525 |

E

Long Shank Burs **Solid Carbide**

Special shank lengths are available up to 18" long

-Our stocking program on Long Shank Carbide Burs provides quick delivery for solving tough, hard-to-reach deburring areas.

- Complete Bur Regrind Service Available

ES

Limas rotativas con zanco largo **Carburo sólido**

Tamaño máximo disponible: 18"

- Nuestro programa de disponibilidad de limas rotativas en carburo sólido de zanco largo proporciona una entrega rápida para solucionar trabajos complicados en zonas difíciles de alcanzar.

- Disponemos de un servicio completo de reafilado de limas rotativas

FR

Fraises-limes à queue longue **Carbure monobloc**

Disponibles jusqu'à 18" de long

- Notre programme d'ébauche pour les fraises rotatives en carbure à queue longue permet une livraison rapide permettant de résoudre les problèmes concernant les zones d'ébavurage tenaces et difficiles à atteindre.

- Service de réaffûtage complet de fraises rotatives disponible

TECHNICAL

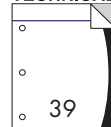

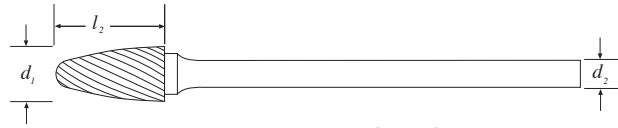

Tree Shape Radius End
Forma de árbol Con radio
Forme d'ogive Bout hémisphérique



E

Long Shank Burs
Solid Carbide

Special shank lengths are available up to 18" long
 - Our stocking program on Long Shank Carbide Burs provides quick delivery for solving tough, hard-to-reach deburring areas.
 - Complete Bur Regrind Service Available

| Tool No. | Cutter Diameter d_1 | Length of Cut l_2 | Shank Diameter d_2 | Double Cut EDP No. | Single Cut EDP No. |
|----------|--------------------------|------------------------|-------------------------|-----------------------|-----------------------|
| SF-1L6 | 1/4 | 1/2 | 1/4 | 16553 | 16550 |
| SF-3L6 | 3/8 | 3/4 | 1/4 | 16578 | 16575 |
| SF-5L6 | 1/2 | 1 | 1/4 | 16603 | 16600 |

ES

Limas rotativas de zanco largo
Carburo sólido

Tamaño máximo disponible: 18"
 - Nuestro programa de disponibilidad de limas rotativas en carburo sólido de zanco largo proporciona una entrega rápida para solucionar trabajos complicados en zonas difíciles de alcanzar.
 - Disponemos de un servicio completo de reafilado de limas rotativas

Tree Shape Pointed End
Forma de árbol
Forme d'ogive À bout pointu



| Tool No. | Cutter Diameter d_1 | Length of Cut l_2 | Shank Diameter d_2 | Double Cut EDP No. | Single Cut EDP No. |
|----------|--------------------------|------------------------|-------------------------|-----------------------|-----------------------|
| SG-1L6 | 1/4 | 1/2 | 1/4 | 16628 | 16625 |
| SG-3L6 | 3/8 | 3/4 | 1/4 | 16653 | 16650 |
| SG-5L6 | 1/2 | 1 | 1/4 | 16678 | 16675 |

FR

Fraises-limes à queue longue
Carbure monobloc

Disponibles jusqu'à 18" de long
 - Notre programme d'ébauche pour les fraises rotatives en carbure à queue longue permet une livraison rapide permettant de résoudre les problèmes concernant les zones d'ébavurage tenaces et difficiles à atteindre.
 - Service de réaffûtage complet de fraises rotatives disponible

Flame Shape
Forma de llama
Forme en flamme



| Tool No. | Cutter Diameter d_1 | Length of Cut l_2 | Shank Diameter d_2 | Double Cut EDP No. | Single Cut EDP No. |
|----------|--------------------------|------------------------|-------------------------|-----------------------|-----------------------|
| SH-2L6 | 5/16 | 3/4 | 1/4 | 16703 | 16700 |
| SH-5L6 | 1/2 | 1-1/4 | 1/4 | 16728 | 16725 |

14° Taper Radius End
Forma cónica a 14° Con radio
Conique, 14° Bout hémisphérique



| Tool No. | Cutter Diameter d_1 | Length of Cut l_2 | Shank Diameter d_2 | Double Cut EDP No. | Single Cut EDP No. |
|----------|--------------------------|------------------------|-------------------------|-----------------------|-----------------------|
| SL-1L6 | 1/4 | 5/8 | 1/4 | 16753 | 16750 |
| SL-3L6 | 3/8 | 1-1/16 | 1/4 | 16778 | 16775 |
| SL-4L6 | 1/2 | 1-1/8 | 1/4 | 16803 | 16800 |

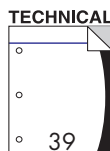

Burs - Mold, Tool & Die Making - Fractional

Limas rotativas para moldes, herramientas y matrices • Fraises-limes pour moulistes, outils et matrices

SGS®

Solid Carbide Tools

$d_2 = 1/8"$ shank diameter
 $d_2 = 1/8"$ diámetro de zanco
 $d_2 = 1/8"$ diamètre de queue

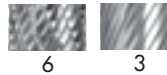
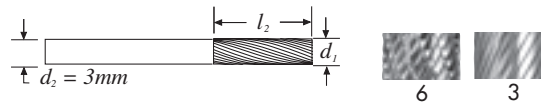

| | Tool No. | Cutter Diameter d_1 | Length of Cut l_2 | Overall Length l_1 | Included Angle α | Double Cut EDP No. | Single Cut EDP No. |
|---------|----------|-----------------------|---------------------|----------------------|-------------------------|--------------------|--------------------|
| | SA-41 | 1/16 | 1/4 | 1-1/2 | | 10603 | 10600 |
| | SA-41L2 | 1/16 | 1/4 | 2 | | 17103 | 17100 |
| | SA-41L3 | 1/16 | 1/4 | 3 | | 17128 | 17125 |
| | SA-42 | 3/32 | 7/16 | 1-1/2 | | 10628 | 10625 |
| | SA-42L2 | 3/32 | 7/16 | 2 | | 17153 | 17150 |
| | SA-42L3 | 3/32 | 7/16 | 3 | | 17178 | 17175 |
| | SA-43 | 1/8 | 9/16 | 1-1/2 | | 10653 | 10650 |
| | SA-43L2 | 1/8 | 9/16 | 2 | | 17203 | 17200 |
| | SA-43L3 | 1/8 | 9/16 | 3 | | 17228 | 17225 |
| | SB-41 | 1/16 | 1/4 | 1-1/2 | | 11453 | 11450 |
| | SB-41L2 | 1/16 | 1/4 | 2 | | 17253 | 17250 |
| | SB-41L3 | 1/16 | 1/4 | 3 | | 17278 | 17275 |
| | SB-42 | 3/32 | 7/16 | 1-1/2 | | 11478 | 11475 |
| | SB-42L2 | 3/32 | 7/16 | 2 | | 17303 | 17300 |
| | SB-42L3 | 3/32 | 7/16 | 3 | | 17328 | 17325 |
| | SB-ECO | 1/8 | | 1-1/2 | | | 11525 |
| | SB-43 | 1/8 | 9/16 | 1-1/2 | | 11503 | 11500 |
| | SB-43L2 | 1/8 | 9/16 | 2 | | 17353 | 17350 |
| SB-43L3 | 1/8 | 9/16 | 3 | | 17378 | 17375 | |
| | SC-41 | 3/32 | 7/16 | 1-1/2 | | 12253 | 12250 |
| | SC-42 | 1/8 | 9/16 | 1-1/2 | | 12278 | 12275 |
| | SC-42L2 | 1/8 | 9/16 | 2 | | 17453 | 17450 |
| | SC-42L3 | 1/8 | 9/16 | 3 | | 17478 | 17475 |
| | SD-41 | 3/32 | 3/32 | 1-1/2 | | 12778 | 12775 |
| | SD-42 | 1/8 | 1/8 | 1-1/2 | | 12803 | 12800 |
| | SD-42L2 | 1/8 | 1/8 | 2 | | 17553 | 17550 |
| | SD-42L3 | 1/8 | 1/8 | 3 | | 17578 | 17575 |
| | SE-41 | 1/8 | 7/32 | 1-1/2 | | 13153 | 13150 |
| | SE-41L2 | 1/8 | 7/32 | 2 | | 17603 | 17600 |
| | SE-41L3 | 1/8 | 7/32 | 3 | | 17628 | 17625 |
| | SF-41 | 1/8 | 1/4 | 1-1/2 | | 13678 | 13675 |
| | SF-42 | 1/8 | 1/2 | 1-1/2 | | 13703 | 13700 |
| | SF-42L2 | 1/8 | 1/2 | 2 | | 17653 | 17650 |
| | SF-42L3 | 1/8 | 1/2 | 3 | | 17678 | 17675 |
| | SG-41 | 1/8 | 1/4 | 1-1/2 | | 14153 | 14150 |
| | SG-43 | 1/8 | 3/8 | 1-1/2 | | 14203 | 14200 |
| | SG-44 | 1/8 | 1/2 | 1-1/2 | | 14228 | 14225 |
| | SG-44L2 | 1/8 | 1/2 | 2 | | 17853 | 17850 |
| | SG-44L3 | 1/8 | 1/2 | 3 | | 17878 | 17875 |
| | SH-41 | 1/8 | 1/4 | 1-1/2 | | 14553 | 14550 |
| | SH-41L2 | 1/8 | 1/4 | 2 | | 17903 | 17900 |
| | SH-41L3 | 1/8 | 1/4 | 3 | | 17928 | 17925 |
| | SJ-42 | 1/8 | 3/32 | 1-1/2 | 60° | 14903 | 14900 |
| | SK-42 | 1/8 | 1/16 | 1-1/2 | 90° | 15153 | 15150 |
| | SL-41 | 1/8 | 3/8 | 1-1/2 | 8° | 15403 | 15400 |
| | SL-42 | 1/8 | 1/2 | 1-1/2 | 8° | 15428 | 15425 |
| | SL-42L2 | 1/8 | 1/2 | 2 | 8° | 17953 | 17950 |
| | SL-42L3 | 1/8 | 1/2 | 3 | 8° | 17978 | 17975 |
| | SM-41 | 1/8 | 11/32 | 1-1/2 | 12° | 15678 | 15675 |
| | SM-42 | 1/8 | 7/16 | 1-1/2 | 14° | 15703 | 15700 |
| | SM-42L2 | 1/8 | 7/16 | 2 | 14° | 18053 | 18050 |
| | SM-42L3 | 1/8 | 7/16 | 3 | 14° | 18078 | 18075 |
| | SM-43 | 1/8 | 5/8 | 1-1/2 | 7° | 15728 | 15725 |
| | SN-41 | 3/32 | 1/8 | 1-1/2 | 10° | 16028 | 16025 |
| | SN-42 | 1/8 | 3/16 | 1-1/2 | 10° | 16053 | 16050 |

E

Mold, Tool & Die Making Burs

Solid Carbide

- Complete Bur Regrind service Available

ES

Limas rotativas para moldes, herramientas y matrices

Carburo sólido

- Disponemos de un servicio completo de reafilado de limas rotativas

FR

Fraises-limes pour moulistes, outils et matrices

Carbure monobloc

- Service de réaffûtage complet de fraises rotatives disponible

TECHNICAL

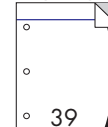

1/4" Head - 1/8" Shank

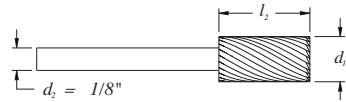

| Tool No. | Cutter Diameter d_1 | Length of Cut l_2 | Shank Diameter d_2 | Included Angle α | Cut | |
|----------|--------------------------|------------------------|-------------------------|----------------------------|--------------------|--------------------|
| | | | | | 6 | 3 |
| | | | | | Double Cut EDP No. | Single Cut EDP No. |
| SA-51 | 1/4 | 1/2 | 1/8 | | 10678 | 10675 |
| SB-51 | 1/4 | 3/16 | 1/8 | | 11553 | 11550 |
| SC-51 | 1/4 | 1/2 | 1/8 | | 12303 | 12300 |
| SD-51 | 1/4 | 7/32 | 1/8 | | 12828 | 12825 |
| SE-51 | 1/4 | 3/8 | 1/8 | | 13178 | 13175 |
| SF-51 | 1/4 | 1/2 | 1/8 | | 13728 | 13725 |
| SG-51 | 1/4 | 1/2 | 1/8 | | 14253 | 14250 |
| SM-51 | 1/4 | 1/2 | 1/8 | 22° | 15753 | 15750 |
| SN-51 | 1/4 | 1/4 | 1/8 | 10° | 16078 | 16075 |

E

Mold, Tool & Die Making Burs

1/4" Head - 1/8" Shank - Brazed Construction 5/32" - 3/16" Head, 1/8" Shank - Solid Carbide

Complete Bur Regrind Service Available

ES

Limas rotativas para moldes, herramientas y matrices

Cabeza de 1/4" - Zanco de 1/8" con construcción de soldadura de bronce
Cabeza de 5/32" - 3/16" -

Zanco de 1/8" - Carburo sólido

Disponemos de un servicio completo de reafilado de limas rotativas

FR

Fraises-limes pour mouliste, outils et matrices

Tête de 1/4" - Queue de 1/8" - Brasées
Tête de 5/32" - 3/16" - Queue de 1/8" - Carbure monobloc

Service de réaffûtage complet de fraises rotatives disponible

5/32", 3/16" Heads - 1/8" Shank

| Tool No. | Cutter Diameter d_1 | Length of Cut l_2 | Shank Diameter d_2 | Included Angle α | Cut | |
|----------|--------------------------|------------------------|-------------------------|----------------------------|--------------------|--------------------|
| | | | | | 6 | 3 |
| | | | | | Double Cut EDP No. | Single Cut EDP No. |
| SA-52 | 5/32 | 1/2 | 1/8 | | 10703 | 10700 |
| SA-53 | 3/16 | 1/2 | 1/8 | | 10728 | 10725 |
| SC-52 | 5/32 | 1/2 | 1/8 | | 12328 | 12325 |
| SC-53 | 3/16 | 1/2 | 1/8 | | 12353 | 12350 |
| SD-52 | 5/32 | 5/32 | 1/8 | | 12840 | 12837 |
| SD-53 | 3/16 | 5/32 | 1/8 | | 12853 | 12850 |
| SE-53 | 3/16 | 9/32 | 1/8 | | 13203 | 13200 |
| SF-53 | 3/16 | 1/2 | 1/8 | | 13753 | 13750 |
| SG-53 | 3/16 | 1/2 | 1/8 | | 14278 | 14275 |
| SH-53 | 3/16 | 3/8 | 1/8 | | 14603 | 14600 |
| SL-53 | 3/16 | 1/2 | 1/8 | 14° | 15453 | 15450 |
| SM-53 | 3/16 | 1/2 | 1/8 | 16° | 15778 | 15775 |
| SN-53 | 3/16 | 1/4 | 1/8 | 10° | 16103 | 16100 |

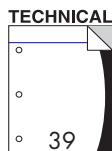

Bur Sets - Solid Carbide - Fractional

Juegos de limas rotativas - Carburo sólido • Jeux de fraises-limes - Carbone monobloc

SET #1

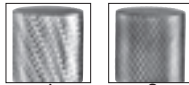

| | |
|-----------------------------------|-----------------------------------|
| 6 | 3 |
| Double Cut EDP No. 18201 | Single Cut EDP No. 18200 |



E

Solid Carbide Miniature Bur Set #1

1/8" Shank Diameter - 1-1/2" Overall Length.

Contains the following twelve 1/8" Burs in a sturdy oak box:
SA-42, SA-43, SC-41, SC-42, SD-42, SE-41, SF-42, SG-43, SH-41,
SL-42, SM-42, SN-42

Solid Carbide Miniature Bur Set #2

3/32" Shank Diameter - 1-1/4" Overall Length.

Contains the following nine 3/32" Burs in a sturdy oak box:
SA-61, SA-63, SC-61, SD-61, SE-61, SF-61, SG-61, SM-61, SN-61

Solid Carbide Miniature Bur Set #4

3/16" Shank Diameter - 2" Overall Length.

Contains the following eight 3/16" Burs in a sturdy oak box:
SA-81, SC-81, SD-81, SE-81, SF-81, SG-81, SL-81, SN-81

SET #2



| | |
|-----------------------------------|-----------------------------------|
| 6 | 3 |
| Double Cut EDP No. 18203 | Single Cut EDP No. 18202 |

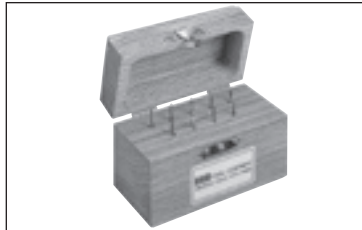

ES

Juego de caja #1 de limas rotativas miniatura en carburo sólido

Zanco de diámetro 1/8" - Longitud total 1-1/2"

Contiene las siguientes nueve rotativas de 1/8" en una caja de madera de roble: SA-42, SA-43, SC-41, SC-42, SD-42, SE-41, SF-42, SG-43, SH-41, SL-42, SM-42, SN-42

Juego de caja #2 de limas rotativas miniatura en carburo sólido

Zanco de diámetro 3/32" - Longitud total 1-1/4"

Contiene las siguientes nueve rotativas de 3/32" en una caja de madera de roble: SA-61, SA-63, SC-61, SD-61, SE-61, SF-61, SG-61, SM-61, SN-61

Juego de caja #4 de limas rotativas miniatura en carburo sólido

Zanco de diámetro 3/16" - Longitud total 2"

Contiene las siguientes ocho rotativas de 3/16" en una caja de madera de roble: SA-81, SC-81, SD-81, SE-81, SF-81, SG-81, SL-81, SN-81

SET #4



| | |
|-----------------------------------|-----------------------------------|
| 6 | 3 |
| Double Cut EDP No. 18207 | Single Cut EDP No. 18206 |



FR

Jeu de Mini-Fraises rotatives en carbure monobloc N°1

Diamètre de la queue 1/8" - Longueur totale 1-1/2"

Contient les douze fraises rotatives 1/8" suivantes dans un coffret en chêne robuste: SA-42, SA-43, SC-41, SC-42, SD-42, SE-41, SF-42, SG-43, SH-41, SL-42, SM-42, SN-42

Jeu de Mini-Fraises rotatives en carbure monobloc N°2

Diamètre de la queue 3/32" - Longueur totale 1-1/4"

Contient les neuf fraises rotatives 3/32" suivantes dans un coffret en chêne robuste: SA-61, SA-63, SC-61, SD-61, SE-61, SF-61, SG-61, SM-61, SN-61

Jeu de Mini-Fraises rotatives en carbure monobloc N°4

Diamètre de la queue 3/16" - Longueur totale 2"

Contient les huit fraises rotatives 3/16" suivantes dans un coffret en chêne robuste: SA-81, SC-81, SD-81, SE-81, SF-81, SG-81, SL-81, SN-81

E

Miniature Bur Set #5

1/8" Steel Shank Diameter.

Contains the following nine Burs in a sturdy oak box:
SA-51, SB-51, SC-51, SD-51, SE-51, SF-51, SG-51, SM-51, SN-51

Solid Carbide Miniature Bur Set #6

1/4" steel shank diameter

Contains the following eight burs in a sturdy oak box:
SA-5, SC-3, SC-5, SD-5, SF-3, SF-5, SG-3, SL-4

ES

Juego de caja #5 de limas rotativas miniatura

Zanco de acero de diámetro 1/8"

Contiene las siguientes nueve rotativas en una caja de madera de roble:

SA-51, SB-51, SC-51, SD-51, SE-51, SF-51, SG-51, SM-51, SN-51

Juego de caja #6 de limas rotativas en carburo sólido

Zanco de acero de diámetro 1/4"

Contiene las siguientes ocho rotativas en una caja de madera de roble:

SA-5, SC-3, SC-5, SD-5, SF-3, SF-5, SG-3, SL-4

FR

Jeu de Mini-Fraises rotatives N°5

Queue en acier, diamètre 1/8" - Longueur totale 2"

Contient les neuf fraises rotatives 1/8" suivantes dans un coffret en chêne robuste:

SA-51, SB-51, SC-51, SD-51, SE-51, SF-51, SG-51, SM-51, SN-51

Jeu de Fraises rotatives N°6

Queue en acier, diamètre 1/4"

Contient les huit fraises rotatives dans un coffret en chêne robuste:

SA-5, SC-3, SC-5, SD-5M, SF-3M, SF-5, SG-3, SL-4

#5

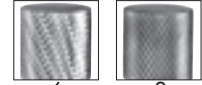

| | |
|-----------------------------------|-----------------------------------|
| 6 | 3 |
| Double Cut EDP No. 18209 | Single Cut EDP No. 18208 |

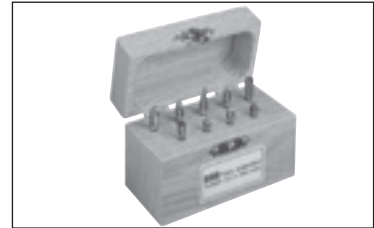

#6

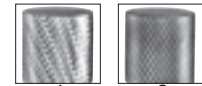

| | |
|-----------------------------------|-----------------------------------|
| 6 | 3 |
| Double Cut EDP No. 18211 | Single Cut EDP No. 18210 |



Bur Sets - Solid Carbide - Fractional

Juegos de limas rotativas - Carburo sólido • Jeux de fraises-limes - Carbure monobloc

SGS®

Solid Carbide Tools

#7



6
Double
Cut
EDP No.
18213

3
Single
Cut
EDP No.
18212

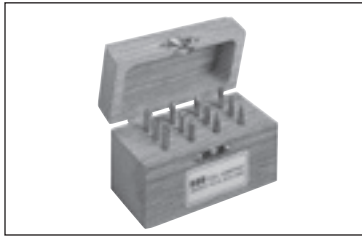

E

Solid Carbide Miniature Bur Set #7

1/8" diameter solid carbide shank, 1-1/2" overall length
Contains the following twelve burs in a sturdy oak box:
SA-52, SA-53, SC-52, SC-53, SD-53, SE-53, SF-53, SG-53, SH-53,
SL-53, SM-53, SN-53

Extra Long Bur Set #8

1/4" diameter - 6" long steel shank
Contains the following eight burs in a clear/blue acrylic case:
SA-1L6, SA-5L6, SC-1L6, SC-5L6, SD-1L6, SF-1L6, SG-1L6, SL-1L6

ES

Juego de caja #7 de limas rotativas miniatura en carburo sólido

Zanco de carburo sólido de diámetro 1/8" – Longitud total 1-1/2"
Contiene las siguientes doce rotativas en una caja de madera de roble:
SA-52, SA-53, SC-52, SC-53, SD-53, SE-53, SF-53, SG-53, SH-53, SL-53,
SM-53, SN-53

#8



6
Double
Cut
EDP No.
18215

3
Single
Cut
EDP No.
18214



FR

Jeu de Mini-Fraises rotatives en carbure monobloc N°7

Queue en carbure monobloc, diamètre 1/8", Longueur totale 1-1/2"
Contient les douze fraises rotatives dans un coffret en chêne robuste.
SA-52, SA-53, SC-52, SC-53, SD-53, SE-53, SF-53, SG-53, SH-53, SL-53,
SM-53, SN-53

Jeu de Fraises rotatives extra-longues N°8

Queue diamètre 1/4" - queue longue en acier 6"
Contient les huit fraises rotatives dans un étui en acrylique bleu clair:
SA-1L6, SA-5L6, SC-1L6, SC-5L6, SD-1L6, SF-1L6, SG-1L6, SL-1L6

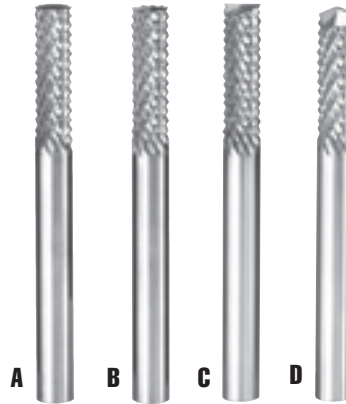
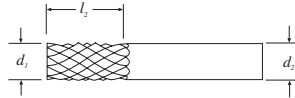

E

Fiberglass Routers

Solid Carbide

For Fiberglass And
Non-Metallic Materials

STYLE A: No End Cut

STYLE B: Bur End

STYLE C: End Mill End

STYLE D: Drill End

| Tool No. | Cutter Diameter d ₁ | Flute Length l ₂ | Shank Diameter d ₂ | Overall Length l ₁ | Uncoated EDP No. | Uncoated EDP No. | Uncoated EDP No. | Uncoated EDP No. |
|----------|--------------------------------|-----------------------------|-------------------------------|-------------------------------|------------------|------------------|------------------|------------------|
| FGR-1 | 1/16 | 3/16 | 1/8 | 1-1/2 | 73001 | 73015 | 73030 | 73045 |
| FGR 1-1 | 3/32 | 3/8 | 1/8 | 1-1/2 | 73002 | 73016 | 73031 | 73046 |
| FGR-2 | 1/8 | 1/2 | 1/8 | 1-1/2 | 73003 | 73017 | 73032 | 73047 |
| FGR-3 | 3/16 | 5/8 | 3/16 | 2 | 73004 | 73018 | 73033 | 73048 |
| FGR-4 | 3/16 | 5/8 | 1/4 | 2 | 73005 | 73019 | 73034 | 73049 |
| FGR-5 | 1/4 | 3/4 | 1/4 | 2 | 73006 | 73020 | 73035 | 73050 |
| FGR-6 | 1/4 | 3/4 | 1/4 | 2-1/2 | 73007 | 73021 | 73036 | 73051 |
| FGR 6-1 | 1/4 | 1 | 1/4 | 3 | 73008 | 73022 | 73037 | 73052 |
| FGR-7 | 5/16 | 1 | 5/16 | 2-1/2 | 73009 | 73023 | 73038 | 73053 |
| FGR-8 | 3/8 | 1 | 3/8 | 2-1/2 | 73010 | 73024 | 73039 | 73054 |
| FGR-9 | 1/2 | 1 | 1/2 | 3 | 73011 | 73025 | 73040 | 73055 |

ES

Fresa para fibra de vidrio

Carburo sólido

Para fibra de vidrio y otros materiales
no metálicos.

ESTILO A: Sin corte frontal

ESTILO B: Con punta de lima rotativa

ESTILO C: Con punta de fresa

ESTILO D: Con punta de broca

FR

Fraises pour fibre de verre

Carbure monobloc

Pour fibres de verre et matières
non-métalliques.

Type A: sans taille en bout

Type B: taille en bout comme fraise-lime

Type C: taille en bout comme fraise

Type D: taille en bout comme foret

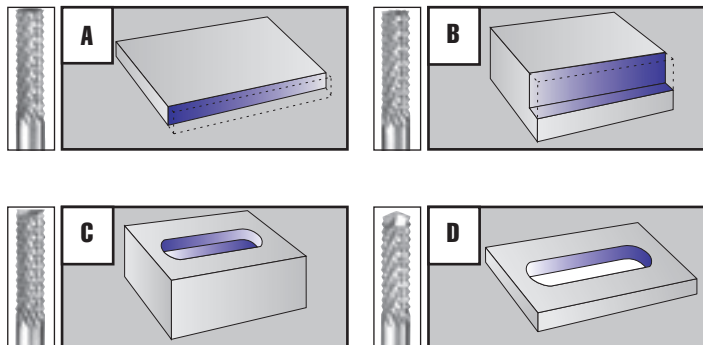



Metric Tool Section

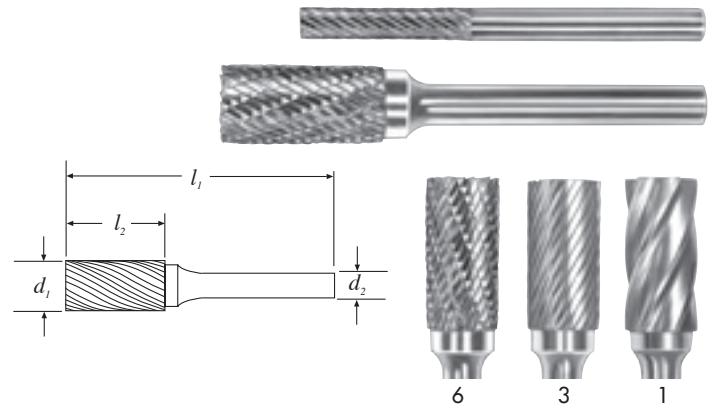

E

Cylinder Shape Burs

Solid Carbide

* 8mm shanks optional
To Order Optional Cuts 4, 3SP, 2, 5
— Specify Quantity, Tool No.
& Optional cut

ES

Limas rotativas forma cilíndrica Metal duro

* Mango de 8 mm opcional. Para ordenar cortes opcionales 4, 3SP y 2, 5 : Especifique la cantidad, no. de herramienta y tipo de corte opcional.

FR

Fraises - Limes forme cylindrique Carbure monobloc

* Queue de 8 mm en option. Pour commander les coupes en option 4, 3SP, 2, 5 : indiquer la quantité, le N° d'outil et la coupe.

| Tool No. | ød ₁ mm | ød ₂ mm | l ₁ mm | l ₂ mm | EDP No. | EDP No. | EDP No. |
|-----------|--------------------|--------------------|-------------------|-------------------|---------|---------|---------|
| SA-41M | 1,5 | 3 | 38 | 6 | 20603 | 20600 | |
| SA-41ML2 | 1,5 | 3 | 50 | 6 | 27103 | 27100 | |
| SA-41ML3 | 1,5 | 3 | 75 | 6 | 27128 | 27125 | |
| SA-42M | 2,5 | 3 | 38 | 11 | 20628 | 20625 | |
| SA-42ML2 | 2,5 | 3 | 50 | 11 | 27153 | 27150 | |
| SA-42ML3 | 2,5 | 3 | 75 | 11 | 27178 | 27175 | |
| SA-43M | 3 | 3 | 38 | 14 | 20653 | 20650 | |
| SA-43ML2 | 3 | 3 | 50 | 14 | 27203 | 27200 | |
| SA-43ML3 | 3 | 3 | 75 | 14 | 27228 | 27225 | |
| SA-11M | 3 | 6 | 56 | 12 | 20403 | 20400 | |
| SA-12M | 3 | 6 | 60 | 12,7 | 20428 | 20425 | |
| SA-52M | 4 | 3 | 38 | 12,7 | 20703 | 20700 | |
| SA-13M | 4 | 6 | 50 | 16 | 20453 | 20450 | |
| SA-53M | 5 | 3 | 38 | 12,7 | 20728 | 20725 | |
| SA-14M | 5 | 6 | 50 | 16 | 20478 | 20475 | |
| SA-1M | 6 | 6 | 50 | 16 | 20003 | 20000 | |
| SA-1MNF | 6 | 6 | 50 | 19 | | | 29000 |
| SA-1ML | 6 | 6 | 50 | 25 | 20028 | 20025 | |
| SA-1ML6 | 6 | 6 | 162 | 12,7 | 26178 | 26175 | |
| SA-51M | 6,3 | 3 | 50 | 12,7 | 20678 | 20675 | |
| SA-2M | 8 | 6 | 63 | 19 | 20053 | 20050 | |
| SA-3M | 9,5 | 6 | 63 | 19 | 20078 | 20075 | |
| SA-3MNF | 9,5 | 6 | 63 | 19 | | | 29002 |
| SA-3ML | 9,5 | 6 | 69 | 25 | 20103 | 20100 | |
| SA-3ML6 | 9,5 | 6 | 169 | 19 | 26203 | 26200 | |
| SA-3MZ | 10 | 6 | 60 | 20 | 29101 | 29100 | |
| SA-4M | 11 | 6 | 69 | 25 | 20153 | 20150 | |
| SA-5MZ | 12 | 6 | 65 | 25 | 29105 | 29104 | |
| SA-5M | 12,7 | 6 | 69 | 25 | 20178 | 20175 | |
| SA-5MNF | 12,7 | 6 | 69 | 25 | | | 29004 |
| SA-5ML6 | 12,7 | 6 | 175 | 25 | 26228 | 26225 | |
| * SA-6M | 16 | 6 | 69 | 25 | 20203 | 20200 | |
| * SA-6MNF | 16 | 6 | 69 | 25 | | | 29006 |
| * SA-7M | 19 | 6 | 69 | 25 | 20253 | 20250 | |
| * SA-7MNF | 19 | 6 | 69 | 25 | | | 29008 |
| SA-7MNF | 19 | 8 | 69 | 25 | | | 29010 |
| * SA-9M | 25 | 6 | 69 | 25 | 20353 | 20350 | |

TECHNICAL

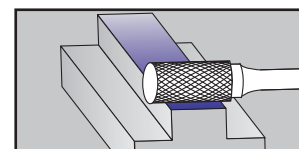
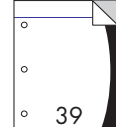

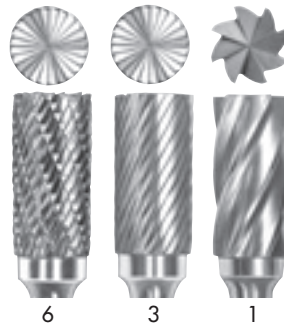
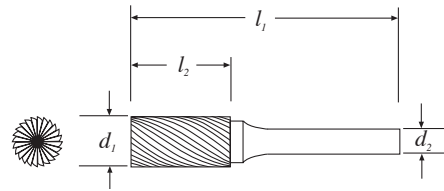
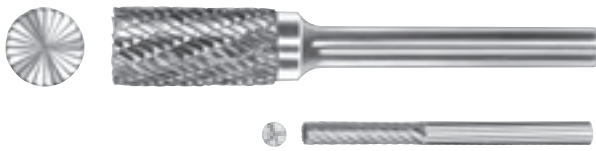

| Tool No. | $\varnothing d_1$ mm | $\varnothing d_2$ mm | l_1 mm | l_2 mm | EDP No. | EDP No. | EDP No. |
|-----------|----------------------|----------------------|----------|----------|---------|---------|---------|
| SB-41M | 1,5 | 3 | 38 | 6 | 21453 | 21450 | |
| SB-41ML2 | 1,5 | 3 | 50 | 6 | 27253 | 27250 | |
| SB-41ML3 | 1,5 | 3 | 75 | 6 | 27278 | 27275 | |
| SB-42M | 2,5 | 3 | 38 | 11 | 21478 | 21475 | |
| SB-42ML2 | 2,5 | 3 | 50 | 11 | 27303 | 27300 | |
| SB-42ML3 | 2,5 | 3 | 75 | 11 | 27328 | 27325 | |
| SB-ECOM | 3 | 3 | 38 | | | 21525 | |
| SB-43M | 3 | 3 | 38 | 14 | 21503 | 21500 | |
| SB-43ML2 | 3 | 3 | 50 | 14 | 27353 | 27350 | |
| SB-43ML3 | 3 | 3 | 75 | 14 | 27378 | 27375 | |
| SB-11M | 3 | 6 | 56 | 12 | 21253 | 21250 | |
| SB-12M | 3 | 6 | 60 | 12,7 | 21278 | 21275 | |
| SB-13M | 4 | 6 | 50 | 16 | 21303 | 21300 | |
| SB-14M | 5 | 6 | 50 | 16 | 21328 | 21325 | |
| SB-1M | 6 | 6 | 50 | 16 | 20853 | 20850 | |
| SB-1MNF | 6 | 6 | 50 | 19 | | | 29012 |
| SB-1ML | 6 | 6 | 50 | 25 | 20873 | 20875 | |
| SB-51M | 6,3 | 3 | 43 | 4,7 | 21553 | 21550 | |
| SB-2M | 8 | 6 | 63 | 19 | 20903 | 20900 | |
| SB-3M | 9,5 | 6 | 63 | 19 | 20928 | 20925 | |
| SB-3MNF | 9,5 | 6 | 63 | 19 | | | 29014 |
| SB-3ML | 9,5 | 6 | 69 | 25 | 20953 | 20950 | |
| SB-3MZ | 10 | 6 | 60 | 20 | 29109 | 29108 | |
| SB-4M | 11 | 6 | 69 | 25 | 21003 | 21000 | |
| SB-5MZ | 12 | 6 | 65 | 25 | 29113 | 29112 | |
| SB-5M | 12,7 | 6 | 69 | 25 | 21028 | 21025 | |
| SB-5MNF | 12,7 | 6 | 69 | 25 | | | 29016 |
| * SB-6M | 16 | 6 | 69 | 25 | 21053 | 21050 | |
| * SB-6MNF | 16 | 6 | 69 | 25 | | | 29018 |
| * SB-7M | 19 | 6 | 69 | 25 | 21103 | 21100 | |
| * SB-7MNF | 19 | 6 | 69 | 25 | | | 29020 |
| SB-7MNF | 19 | 8 | 69 | 25 | | | 29022 |
| * SB-9M | 25 | 6 | 69 | 25 | 21203 | 21200 | |

E

Cylinder Shape Burs with End Cut Solid Carbide

* 8mm shanks optional

To Order Optional Cuts 4, 3SP, 2, 5 – Specify Quantity, Tool No. & Optional cut

ES

Limas rotativas en forma cilíndrica con corte frontal

Metal duro

* Mango de 8 mm opcional. Para ordenar cortes opcionales 4, 3SP y 2, 5 : Especifique la cantidad, no. de herramienta y tipo de corte opcional.

FR

Fraises-limes de forme cylindrique avec denture en bout

Carbure monobloc

* Queue de 8 mm en option. Pour commander les coupes en option 4, 3SP, 2, 5 : indiquer la quantité, le N° d'outil et la coupe.

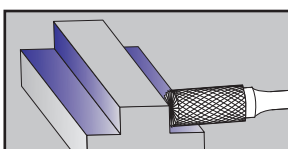

TECHNICAL

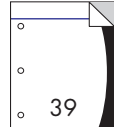

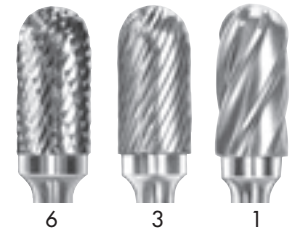
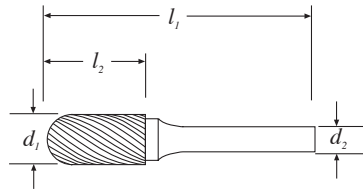

E

**Cylinder Shape Burs with Radius End
Solid Carbide**

* 8mm shanks optional
To Order Optional Cuts 4, 3SP, 2, 5 –
Specify Quantity, Tool No. & Optional cut

ES

**Limas rotativas en forma
cilíndrica con radio
Metal duro**

* Mango de 8 mm opcional. Para
ordenar cortes opcionales 4, 3SP y 2, 5 :
Especifique la cantidad, no. de
herramienta y tipo de corte opcional.

FR

**Fraises-limes de forme
cylindrique à bout hémisphérique
Carbure monobloc**

* Queue de 8 mm en option. Pour
commander les coupes en option 4,
3SP, 2, 5 : indiquer la quantité, le
N° d'outil et la coupe.

| Tool No. | ød ₁ mm | ød ₂ mm | l ₁ mm | l ₂ mm | EDP No. | EDP No. | EDP No. |
|-----------|--------------------|--------------------|-------------------|-------------------|---------|---------|---------|
| SC-41M | 2,5 | 3 | 38 | 11 | 22253 | 22250 | |
| SC-42M | 3 | 3 | 38 | 14 | 22278 | 22275 | |
| SC-42ML2 | 3 | 3 | 50 | 14 | 27453 | 27450 | |
| SC-42ML3 | 3 | 3 | 75 | 14 | 27478 | 27475 | |
| SC-11M | 3 | 6 | 56 | 12 | 22053 | 22050 | |
| SC-12M | 3 | 6 | 60 | 16 | 22078 | 22075 | |
| SC-52M | 4 | 3 | 38 | 12,7 | 22328 | 22325 | |
| SC-13M | 4 | 6 | 50 | 16 | 22103 | 22100 | |
| SC-53M | 5 | 3 | 38 | 12,7 | 22353 | 22350 | |
| SC-14M | 5 | 6 | 50 | 16 | 22128 | 22125 | |
| SC-1M | 6 | 6 | 50 | 16 | 21703 | 21700 | |
| SC-1MNF | 6 | 6 | 50 | 19 | | | 29024 |
| SC-1ML | 6 | 6 | 50 | 25 | 21728 | 21725 | |
| SC-1ML6 | 6 | 6 | 162 | 12,7 | 26328 | 26325 | |
| SC-51M | 6,3 | 3 | 50 | 12,7 | 22303 | 22300 | |
| SC-2M | 8 | 6 | 63 | 19 | 21753 | 21750 | |
| SC-3M | 9,5 | 6 | 63 | 19 | 21778 | 21775 | |
| SC-3MNF | 9,5 | 6 | 63 | 19 | | | 29026 |
| SC-3ML | 9,5 | 6 | 69 | 25 | 21803 | 21800 | |
| SC-3ML6 | 9,5 | 6 | 169 | 19 | 26353 | 26350 | |
| SC-3MZ | 10 | 6 | 60 | 20 | 29117 | 29116 | |
| SC-4M | 11 | 6 | 69 | 25 | 21853 | 21850 | |
| SC-5MZ | 12 | 6 | 65 | 25 | 29121 | 29120 | |
| SC-5M | 12,7 | 6 | 69 | 25 | 21878 | 21875 | |
| SC-5ML6 | 12,7 | 6 | 175 | 25 | 26378 | 26375 | |
| SC-5MNF | 12,7 | 6 | 69 | 25 | | | 29028 |
| * SC-6M | 16 | 6 | 69 | 25 | 21903 | 21900 | |
| * SC-7M | 19 | 6 | 69 | 25 | 21953 | 21950 | |
| * SC-7MNF | 19 | 6 | 69 | 25 | | | 29032 |
| SC-7MNF | 19 | 8 | 69 | 25 | | | 29034 |
| * SC-9M | 25 | 6 | 69 | 25 | 22003 | 22000 | |

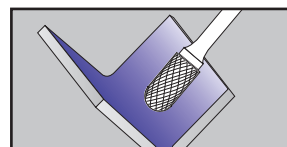
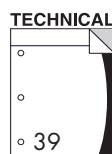

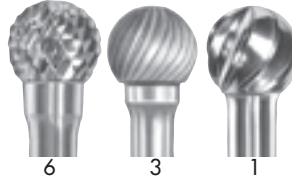
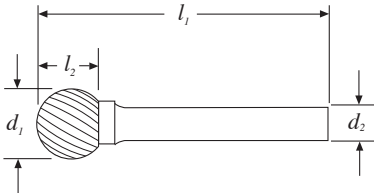

| Tool No. | ød ₁ mm | ød ₂ mm | l ₁ mm | l ₂ mm | EDP No. | EDP No. | EDP No. |
|----------|-----------------------|-----------------------|----------------------|----------------------|---------|---------|---------|
| SD-41M | 2,5 | 3 | 38 | 2,3 | 22778 | 22775 | |
| SD-42M | 3 | 3 | 38 | 2,5 | 22803 | 22800 | |
| SD-42ML2 | 3 | 3 | 50 | 2,5 | 27553 | 27550 | |
| SD-42ML3 | 3 | 3 | 75 | 2,5 | 27578 | 27575 | |
| SD-11M | 3 | 6 | 50 | 2,5 | 22728 | 22725 | |
| SD-52M | 4 | 3 | 38 | 3,4 | 22840 | 22837 | |
| SD-53M | 5 | 3 | 38 | 4,7 | 22853 | 22850 | |
| SD-14M | 5 | 6 | 50 | 4 | 22753 | 22750 | |
| SD-1M | 6 | 6 | 50 | 5 | 22453 | 22450 | |
| SD-1ML6 | 6 | 6 | 155 | 5 | 26403 | 26400 | |
| SD-1MNF | 6 | 6 | 50 | 5 | | | 29036 |
| SD-51M | 6,3 | 3 | 44 | 5 | 22828 | 22825 | |
| SD-2M | 8 | 6 | 50 | 6,4 | 22478 | 22475 | |
| SD-3M | 9,5 | 6 | 52 | 8 | 22503 | 22500 | |
| SD-3MNF | 9,5 | 6 | 52 | 8 | | | 29038 |
| SD-3ML6 | 9,5 | 6 | 158 | 8 | 26428 | 26425 | |
| SD-3MZ | 10 | 6 | 49 | 9 | 29125 | 29124 | |
| SD-4M | 11 | 6 | 54 | 9,5 | 22528 | 22525 | |
| SD-5MZ | 12 | 6 | 51 | 10,8 | 29129 | 29128 | |
| SD-5M | 12,7 | 6 | 55 | 11 | 22553 | 22550 | |
| SD-5MNF | 12,7 | 6 | 55 | 11 | | | 29040 |
| SD-5ML6 | 12,7 | 6 | 161 | 11 | 26453 | 26450 | |
| *SD-6M | 16 | 6 | 58 | 14 | 22578 | 22575 | |
| *SD-6MNF | 16 | 6 | 58 | 14 | | | 29042 |
| *SD-7M | 19 | 6 | 62 | 16 | 22628 | 22625 | |
| SD-7MNF | 19 | 6 | 62 | 16 | | | 29044 |
| *SD-7MNF | 19 | 8 | 62 | 16 | | | 29046 |
| SD-9M | 25 | 6 | 72 | 21 | 22678 | 22675 | |

E

Ball Shape Burs**Solid Carbide**

* 8mm shanks optional

To Order Optional Cuts 4, 3SP, 2, 5 – Specify Quantity, Tool No. & Optional cut

ES

Limas rotativas esféricas**Metal duro**

* Mango de 8 mm opcional. Para ordenar cortes opcionales 4, 3SP y 2, 5 : Especifique la cantidad, no. de herramienta y tipo de corte opcional.

FR

Fraises-limes de forme sphérique**Carbure monobloc**

* Queue de 8 mm en option. Pour commander les coupes en option 4, 3SP, 2, 5 : indiquer la quantité, le N° d'outil et la coupe.

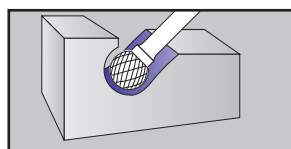

TECHNICAL

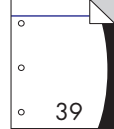

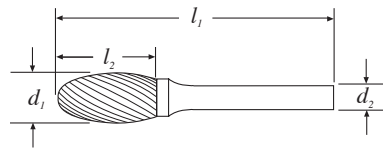

E

Oval Shape Burs
Solid Carbide

* 8mm shanks optional
To Order Optional Cuts 4, 3SP, 2, 5 –
Specify Quantity, Tool No. &
Optional cut

ES

Limas rotativas en forma ovalada

Metal duro
* Mango de 8 mm opcional. Para ordenar cortes opcionales 4, 3SP y 2, 5 : Especifique la cantidad, no. de herramienta y tipo de corte opcional.

FR

Fraises-limes de forme ovale

Carbure monobloc
* Queue de 8 mm en option. Pour commander les coupes en option 4, 3SP, 2, 5 : indiquer la quantité, le N° d'outil et la coupe.

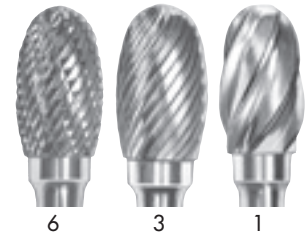

| Tool No. | ød ₁ mm | ød ₂ mm | l ₁ mm | l ₂ mm | 6 | 3 | 1 |
|-----------|-----------------------|-----------------------|----------------------|----------------------|---------|---------|---------|
| | | | | | EDP No. | EDP No. | EDP No. |
| SE-41M | 3 | 3 | 38 | 5,5 | 23153 | 23150 | |
| SE-41ML2 | 3 | 3 | 50 | 5,5 | 27603 | 27600 | |
| SE-41ML3 | 3 | 3 | 75 | 5,5 | 27628 | 27625 | |
| SE-53M | 5 | 3 | 38 | 7,1 | 23203 | 23200 | |
| SE-1M | 6 | 6 | 50 | 9,5 | 22953 | 22950 | |
| SE-1ML6 | 6 | 6 | 160 | 9,5 | 26478 | 26475 | |
| SE-51M | 6,3 | 3 | 47 | 9,5 | 23178 | 23175 | |
| SE-3M | 9,5 | 6 | 60 | 16 | 22978 | 22975 | |
| SE-3ML6 | 9,5 | 6 | 166 | 16 | 26503 | 26500 | |
| SE-3MNF | 9,5 | 6 | 60 | 16 | | | 29048 |
| SE-5M | 12,7 | 6 | 66 | 22 | 23003 | 23000 | |
| SE-5ML6 | 12,7 | 6 | 172 | 22 | 26528 | 26525 | |
| SE-5MNF | 12,7 | 6 | 66 | 22 | | | 29050 |
| * SE-6M | 16 | 6 | 69 | 25 | 23028 | 23025 | |
| * SE-6MNF | 16 | 6 | 69 | 25 | | | 29052 |
| * SE-7M | 19 | 6 | 69 | 25 | 23078 | 23075 | |
| * SE-7MNF | 19 | 6 | 69 | 25 | | | 29054 |
| SE-7MNF | 19 | 8 | 69 | 25 | | | 29056 |

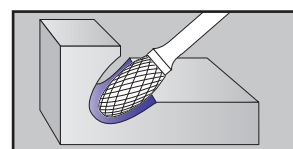
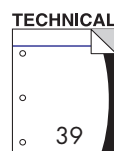

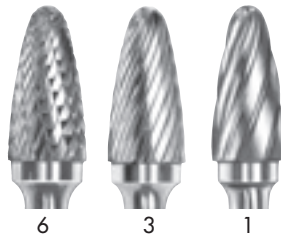
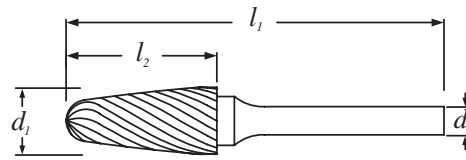

| Tool No. | ød ₁ mm | ød ₂ mm | l ₁ mm | l ₂ mm | | | |
|------------|-----------------------|-----------------------|----------------------|----------------------|---------|---------|---------|
| | | | | | 6 | 3 | 1 |
| | | | | | EDP No. | EDP No. | EDP No. |
| SF-41M | 3 | 3 | 38 | 6 | 23678 | 23675 | |
| SF-42M | 3 | 3 | 38 | 12,7 | 23703 | 23700 | |
| SF-11M | 3 | 6 | 56 | 12,7 | 23503 | 23500 | |
| SF-42ML2 | 3 | 3 | 50 | 12,7 | 27653 | 27650 | |
| SF-42ML3 | 3 | 3 | 75 | 12,7 | 27678 | 27675 | |
| SF-53M | 5 | 3 | 38 | 12,7 | 23753 | 23750 | |
| SF-1M | 6 | 6 | 50 | 16 | 23303 | 23300 | |
| SF-1ML6 | 6 | 6 | 163 | 12,7 | 26553 | 26550 | |
| SF-1MNF | 6 | 6 | 50 | 19 | | | 29058 |
| SF-51M | 6,3 | 3 | 50 | 12,7 | 23728 | 23725 | |
| SF-3M | 9,5 | 6 | 63 | 19 | 23328 | 23325 | |
| SF-3ML6 | 9,5 | 6 | 169 | 19 | 26578 | 26575 | |
| SF-3MNF | 9,5 | 6 | 63 | 19 | | | 29060 |
| SF-4M | 11 | 6 | 69 | 25 | 23353 | 23350 | |
| SF-5MZ | 12 | 6 | 65 | 25 | 23522 | 23520 | |
| SF-13M | 12,7 | 6 | 63 | 19 | 23528 | 23525 | |
| SF-5M | 12,7 | 6 | 69 | 25 | 23378 | 23375 | |
| SF-5ML6 | 12,7 | 6 | 175 | 25 | 26603 | 26600 | |
| SF-5MNF | 12,7 | 6 | 69 | 25 | | | 29062 |
| * SF-6M | 16 | 6 | 69 | 25 | 23403 | 23400 | |
| * SF-6MNF | 16 | 6 | 69 | 25 | | | 29064 |
| * SF-7M | 19 | 6 | 69 | 25 | 23453 | 23450 | |
| * SF-14M | 19 | 6 | 76 | 32 | 23578 | 23575 | |
| * SF-14MNF | 19 | 6 | 76 | 32 | | | 29066 |
| SF-14MNF | 19 | 8 | 76 | 32 | | | 29068 |
| * SF-15M | 19 | 6 | 82 | 38 | 23628 | 23625 | |

E

Tree Shape Burs with Radius End Solid Carbide

* 8mm shanks optional

To Order Optional Cuts 4, 3SP, 2, 5 – Specify Quantity, Tool No. & Optional cut

ES

Limas rotativas en forma de árbol con radio Metal duro

Metal duro

* Mango de 8 mm opcional. Para ordenar cortes opcionales 4, 3SP y 2, 5 : Especifique la cantidad, no. de herramienta y tipo de corte opcional.

FR

Fraises-limes en forme d'ogive à bout hémisphérique Carbure monobloc

Carbure monobloc

* Queue de 8 mm en option. Pour commander les coupes en option 4, 3SP, 2, 5 : indiquer la quantité, le N° d'outil et la coupe.

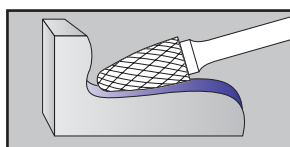

TECHNICAL

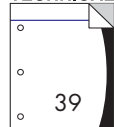

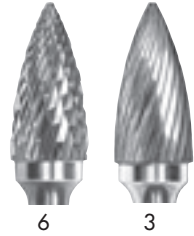
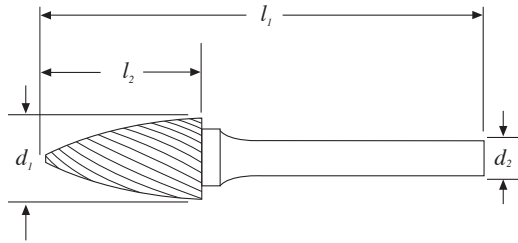

E

**Tree Shape Burs with Pointed End
Solid Carbide**

* 8mm shanks optional
To Order Optional Cuts 4, 3SP, 2, 5 – Specify
Quantity, Tool No. & Optional cut

ES

**Limas rotativas en forma de árbol
Metal duro**

* Mango de 8 mm opcional. Para ordenar cortes
opcionales 4, 3SP y 2, 5 : Especifique la canti-
dad, no. de herramienta y tipo de corte opcional.

FR

**Fraises-limes en forme d'ogive à
bout pointu
Carbure monobloc**

* Queue de 8 mm en option. Pour commander
les coupes en option 4, 3SP, 2, 5 : indiquer la
quantité, le N° d'outil et la coupe.

| Tool No. | ød ₁ mm | ød ₂ mm | l ₁ mm | l ₂ mm | 6 | 3 |
|-------------|-----------------------|-----------------------|----------------------|----------------------|---------|---------|
| | | | | | EDP No. | EDP No. |
| SG-41M | 3 | 3 | 38 | 6 | 24153 | 24150 |
| SG-43M | 3 | 3 | 38 | 9,5 | 24203 | 24200 |
| SG-44M | 3 | 3 | 38 | 12,7 | 24228 | 24225 |
| SG-44ML2 | 3 | 3 | 50 | 12,7 | 27853 | 27850 |
| SG-44ML3 | 3 | 3 | 75 | 12,7 | 27878 | 27875 |
| SG-53M | 5 | 3 | 38 | 12,7 | 24278 | 24275 |
| SG-1M | 6 | 6 | 50 | 16 | 23853 | 23850 |
| SG-1ML6 | 6 | 6 | 163 | 12,7 | 26628 | 26625 |
| SG-51M | 6,3 | 3 | 50 | 12,7 | 24253 | 24250 |
| SG-2M | 8 | 6 | 63 | 19 | 23878 | 23875 |
| SG-3M | 9,5 | 6 | 63 | 19 | 23903 | 23900 |
| SG-3ML6 | 9,5 | 6 | 169 | 19 | 26653 | 26650 |
| SG-3MZ | 10 | 6 | 60 | 20 | 24042 | 24040 |
| SG-5MZ | 12 | 6 | 65 | 25 | 24046 | 24045 |
| SG-13M | 12,7 | 6 | 63 | 19 | 24053 | 24050 |
| SG-5M | 12,7 | 6 | 69 | 25 | 23928 | 23925 |
| SG-5ML6 | 12,7 | 6 | 175 | 25 | 26678 | 26675 |
| * SG-6M | 16 | 6 | 69 | 25 | 23953 | 23950 |
| * SG-7M | 19 | 6 | 69 | 25 | 24003 | 24000 |
| * SG-15M | 19 | 6 | 82 | 38 | 24103 | 24100 |

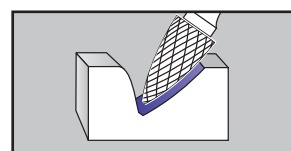

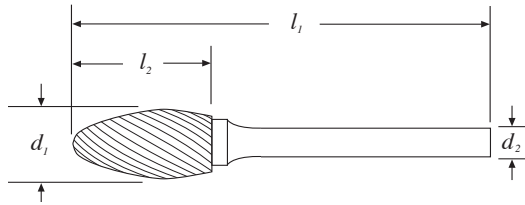

| Tool No. | ød ₁ mm | ød ₂ mm | l ₁ mm | l ₂ mm | EDP No. | EDP No. |
|----------|-----------------------|-----------------------|----------------------|----------------------|---------|---------|
| SH-41M | 3 | 3 | 38 | 6,3 | 24553 | 24550 |
| SH-41ML2 | 3 | 3 | 50 | 6,3 | 27903 | 27900 |
| SH-41ML3 | 3 | 3 | 75 | 6,3 | 27928 | 27925 |
| SH-53M | 5 | 3 | 38 | 9,5 | 24603 | 24600 |
| SH-2M | 8 | 6 | 63 | 19 | 24403 | 24400 |
| SH-2ML6 | 8 | 6 | 169 | 19 | 26703 | 26700 |
| SH-5M | 12,7 | 6 | 76 | 32 | 24428 | 24425 |
| SH-5ML6 | 12,7 | 6 | 182 | 32 | 26728 | 26725 |
| * SH-6M | 16 | 6 | 80 | 36 | 24453 | 24450 |
| * SH-7M | 19 | 6 | 85 | 41 | 24503 | 24500 |

E

Flame Shape Burs Solid Carbide

* 8mm shanks optional

To Order Optional Cuts 4, 3SP, 2, 5 – Specify Quantity, Tool No. & Optional cut

ES

Limas rotativas en forma de llama Metal duro

* Mango de 8 mm opcional. Para ordenar cortes opcionales 4, 3SP y 2, 5 : Especifique la cantidad, no. de herramienta y tipo de corte opcional.

FR

Fraises-limes en forme de flamme Carbure monobloc

* Queue de 8 mm en option. Pour commander les coupes en option 4, 3SP, 2, 5 : indiquer la quantité, le N° d'outil et la coupe.

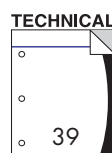
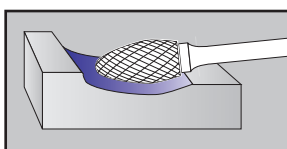

SJ

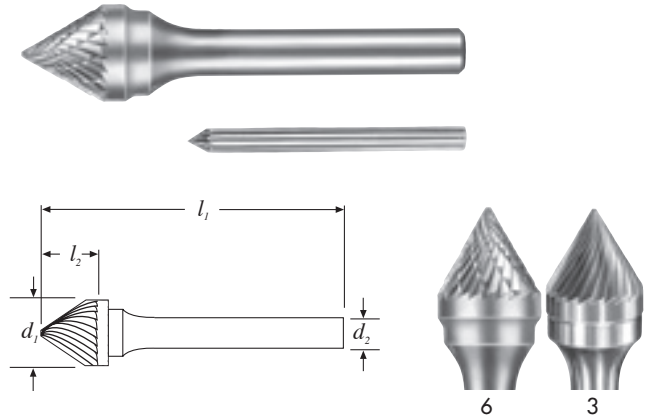

E

SJ - 60° Cone Shape Burs
SK - 90° Cone Shape Burs

Solid Carbide

* 8mm shanks optional - To Order Optional
Cuts 4, 3SP, 2, 5 – Specify Quantity, Tool No. & Optional cut

ES

Limas rotativas cónica

Metal duro

SJ - Forma cónica a 60°

SK - Forma cónica a 90°

* Mango de 8 mm opcional. Para ordenar cortes opcionales 4, 3SP y 2, 5 : Especifique la cantidad, no. de herramienta y tipo de corte opcional.

| Tool No. | ød ₁ mm | ød ₂ mm | l ₁ mm | l ₂ mm | EDP No. | EDP No. |
|----------|--------------------|--------------------|-------------------|-------------------|---------|---------|
| SJ-42M | 3 | 3 | 38 | 2,5 | 24903 | 24900 |
| SJ-1M | 6 | 6 | 50 | 4 | 24678 | 24675 |
| SJ-3M | 9,5 | 6 | 55 | 8 | 24703 | 24700 |
| SJ-5M | 12,7 | 6 | 58 | 11 | 24728 | 24725 |
| * SJ-6M | 16 | 6 | 61 | 14,5 | 24753 | 24750 |
| * SJ-7M | 19 | 6 | 65 | 17,5 | 24803 | 24800 |
| * SJ-9M | 25 | 6 | 68 | 24,5 | 24853 | 24850 |

FR

Fraises-limes de forme conique, à 60° et 90° Carbure monobloc

SJ - Forme conique, 60°

SK - Forme conique, 90°

* Queue de 8 mm en option. Pour commander les coupes en option 4, 3SP, 2, 5 : indiquer la quantité, le N° d'outil et la coupe.

SK

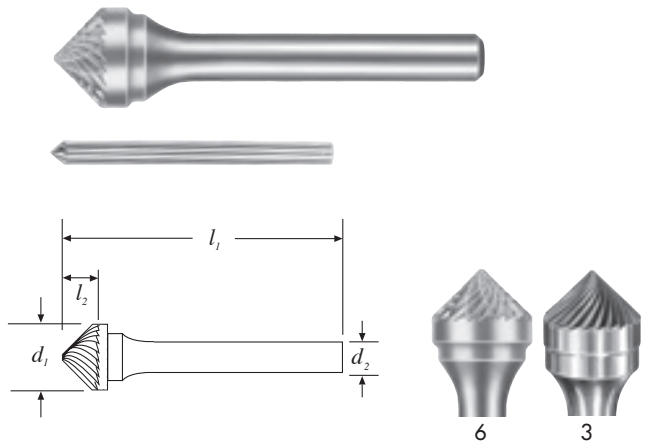

| Tool No. | ød ₁ mm | ød ₂ mm | l ₁ mm | l ₂ mm | EDP No. | EDP No. |
|----------|--------------------|--------------------|-------------------|-------------------|---------|---------|
| SK-42M | 3 | 3 | 38 | 1,5 | 25153 | 25150 |
| SK-1M | 6 | 6 | 50 | 3 | 24928 | 24925 |
| SK-3M | 9,5 | 6 | 52 | 4,7 | 24953 | 24950 |
| SK-5M | 12,7 | 6 | 54 | 6,3 | 24978 | 24975 |
| * SK-6M | 16 | 6 | 57 | 8 | 25003 | 25000 |
| * SK-7M | 19 | 6 | 58 | 9,5 | 25053 | 25050 |
| * SK-9M | 25 | 6 | 60 | 12,7 | 25103 | 25100 |

TECHNICAL

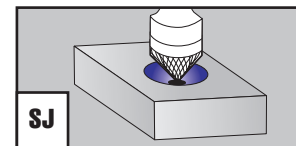
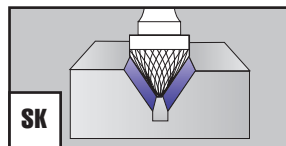
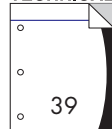

SL Burs - Taper Shape - Radius - Metric

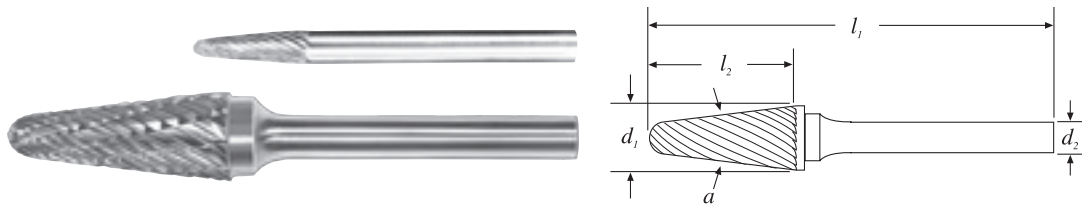

E

**Taper with Radius End Burs
Solid Carbide**

* 8mm shanks optional. To Order Optional Cuts 4, 3SP, 2, 5 - Specify Quantity, Tool No. & Optional Cut

ES

Limas rotativas cónicas a 8°-14° punta esférica

Metal duro

* Mango de 8 mm opcional. Para ordenar cortes opcionales 4, 3SP y 2, 5 : Especifique la cantidad, no. de herramienta y tipo de corte opcional.

FR

Fraises-limes de forme conique, à bout hémisphérique

Carbure monobloc

* Queue de 8 mm en option. Pour commander les coupes en option 4, 3SP, 2, 5 : indiquer la quantité, le N° d'outil et la coupe.

| Tool No. | ød ₁ mm | ød ₂ mm | l ₁ mm | l ₂ mm | α | EDP No. | EDP No. | EDP No. |
|-----------|-----------------------|-----------------------|----------------------|----------------------|-----|---------|---------|---------|
| SL-41M | 3 | 3 | 38 | 9,5 | 8° | 25403 | 25400 | |
| SL-42M | 3 | 3 | 38 | 12,7 | 8° | 25428 | 25425 | |
| SL-42ML2 | 3 | 3 | 50 | 12,7 | 8° | 27953 | 27950 | |
| SL-42ML3 | 3 | 3 | 75 | 12,7 | 8° | 27978 | 27975 | |
| SL-53M | 5 | 3 | 38 | 12,7 | 14° | 25453 | 25450 | |
| SL-1M | 6 | 6 | 50 | 16 | 14° | 25178 | 25175 | |
| SL-1ML6 | 6 | 6 | 166 | 16 | 14° | 26753 | 26750 | |
| SL-2M | 8 | 6 | 69 | 22 | 14° | 25203 | 25200 | |
| SL-3M | 9,5 | 6 | 74 | 27 | 14° | 25228 | 25225 | |
| SL-3MNF | 9,5 | 6 | 74 | 27 | 14° | | | 29070 |
| SL-3ML6 | 9,5 | 6 | 177 | 27 | 14° | 26778 | 26775 | |
| SL-4M | 12,7 | 6 | 76 | 28 | 14° | 25253 | 25250 | |
| SL-4MNF | 12,7 | 6 | 76 | 28 | 14° | | | 29072 |
| SL-4ML6 | 12,7 | 6 | 178 | 28 | 14° | 26803 | 26800 | |
| * SL-5M | 16 | 6 | 77 | 30 | 14° | 25278 | 25275 | |
| * SL-5MNF | 16 | 6 | 77 | 30 | 14° | | | 29074 |
| * SL-7M | 19 | 6 | 85 | 38 | 14° | 25353 | 25350 | |
| * SL-7MNF | 19 | 6 | 85 | 38 | 14° | | | 29078 |
| SL-7MNF | 19 | 8 | 85 | 38 | 14° | | | 29080 |

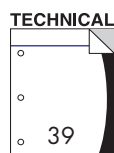
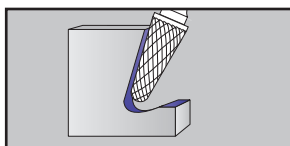

SM

SM

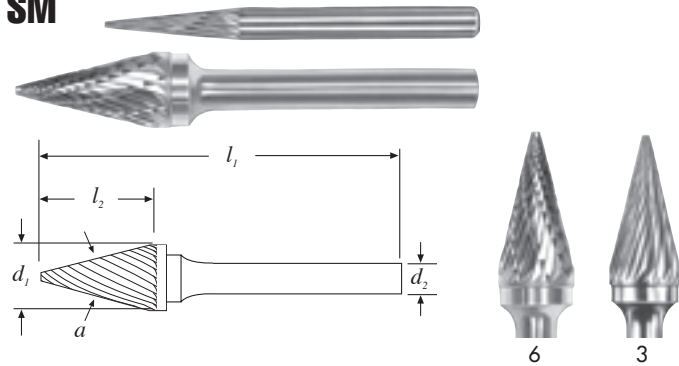

E

Cone (SM) and Inverted Cone (SN) Shape Burs Solid Carbide

* 8mm shanks optional. To Order Optional Cuts 4, 3SP, 2, 5 - Specify Quantity, Tool No. & Optional Cut.

ES

Limas rotativas (SM) cónicas (SN) cónica invertida

Metal duro

* Mango de 8 mm opcional. Para ordenar cortes opcionales 4, 3SP y 2, 5 : Especifique la cantidad, no. de herramienta y tipo de corte opcional.

FR

Fraises-limes (SM) de forme conique et conique inversée (SN)

Carbure monobloc

* Queue de 8 mm en option. Pour commander les coupes en option 4, 3SP, 2, 5 : indiquer la quantité, le N° d'outil et la coupe.

| Tool No. | ød ₁ mm | ød ₂ mm | l ₁ mm | l ₂ mm | α | EDP No. | EDP No. |
|----------|--------------------|--------------------|-------------------|-------------------|-----|---------|---------|
| SM-41M | 3 | 3 | 38 | 8,9 | 12° | 25678 | 25675 |
| SM-42M | 3 | 3 | 38 | 11 | 14° | 25703 | 25700 |
| SM-42ML2 | 3 | 3 | 50 | 11 | 14° | 28053 | 28050 |
| SM-42ML3 | 3 | 3 | 75 | 11 | 14° | 28078 | 28075 |
| SM-43M | 3 | 3 | 38 | 16 | 7° | 25728 | 25725 |
| SM-53M | 5 | 3 | 38 | 12,7 | 16° | 25778 | 25775 |
| SM-1M | 6 | 6 | 50 | 12,7 | 22° | 25503 | 25500 |
| SM-2M | 6 | 6 | 50 | 19 | 14° | 25528 | 25525 |
| SM-3M | 6 | 6 | 50 | 25 | 10° | 25553 | 25550 |
| SM-51M | 6,3 | 3 | 54 | 12,7 | 22° | 25753 | 25750 |
| SM-4M | 9,5 | 6 | 63 | 16 | 28° | 25578 | 25575 |
| SM-5M | 12,7 | 6 | 69 | 22 | 28° | 25603 | 25600 |
| *SM-6M | 16 | 6 | 73 | 25 | 31° | 25628 | 25625 |

SN

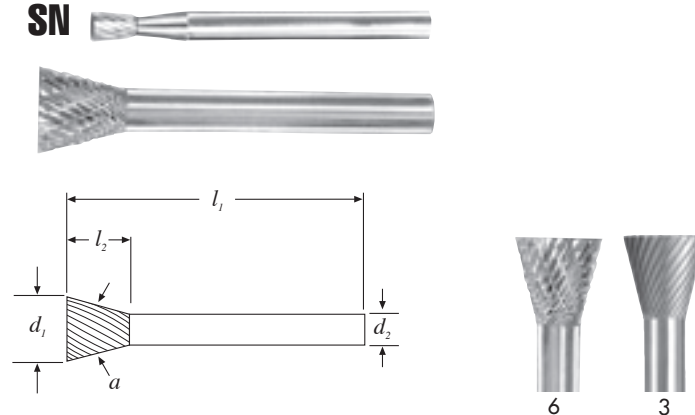

| Tool No. | ød ₁ mm | ød ₂ mm | l ₁ mm | l ₂ mm | α | EDP No. | EDP No. |
|----------|--------------------|--------------------|-------------------|-------------------|-----|---------|---------|
| SN-41M | 2,5 | 3 | 38 | 3 | 10° | 26028 | 26025 |
| SN-42M | 3 | 3 | 38 | 4 | 10° | 26053 | 26050 |
| SN-53M | 5 | 3 | 38 | 6,3 | 10° | 26103 | 26100 |
| SN-1M | 6 | 6 | 50 | 8 | 10° | 25853 | 25850 |
| SN-51M | 6,3 | 3 | 44 | 6 | 10° | 26078 | 26075 |
| SN-2M | 9,5 | 6 | 53 | 9,5 | 13° | 25878 | 25875 |
| SN-4M | 12,7 | 6 | 57 | 12,7 | 28° | 25903 | 25900 |
| * SN-6M | 16 | 6 | 63 | 19 | 18° | 25928 | 25925 |
| * SN-7M | 19 | 6 | 60 | 16 | 30° | 25978 | 25975 |

TECHNICAL

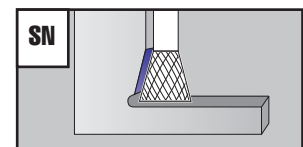
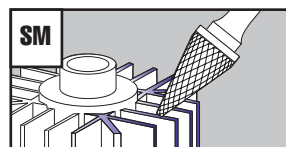
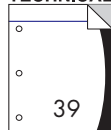

Burs - Mold, Tool & Die Making - Metric

Limas rotativas para moldes, herramientas y matrices • Fraises-limes pour moulistes, outils et matrice

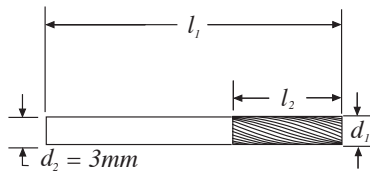

| | Tool No. | ød ₁ mm | ød ₂ mm | l ₁ mm | l ₂ mm | α | 6 | | 3 | |
|--|----------|-----------------------|-----------------------|----------------------|----------------------|-----|---------|---------|---------|---------|
| | | | | | | | EDP No. | EDP No. | EDP No. | EDP No. |
| | SA-41M | 1,5 | 3 | 38 | 6 | | 20603 | 20600 | | |
| | SA-41ML2 | 1,5 | 3 | 50 | 6 | | 27103 | 27100 | | |
| | SA-41ML3 | 1,5 | 3 | 75 | 6 | | 27128 | 27125 | | |
| | SA-42M | 2,5 | 3 | 38 | 11 | | 20628 | 20625 | | |
| | SA-42ML2 | 2,5 | 3 | 50 | 11 | | 27153 | 27150 | | |
| | SA-42ML3 | 2,5 | 3 | 75 | 11 | | 27178 | 27175 | | |
| | SA-43M | 3 | 3 | 38 | 14 | | 20653 | 20650 | | |
| | SA-43ML2 | 3 | 3 | 50 | 14 | | 27203 | 27200 | | |
| | SA-43ML3 | 3 | 3 | 75 | 14 | | 27228 | 27225 | | |
| | SB-41M | 1,5 | 3 | 38 | 6 | | 21453 | 21450 | | |
| | SB-41ML2 | 1,5 | 3 | 50 | 6 | | 27253 | 27250 | | |
| | SB-41ML3 | 1,5 | 3 | 75 | 6 | | 27278 | 27275 | | |
| | SB-42M | 2,5 | 3 | 38 | 11 | | 21478 | 21475 | | |
| | SB-42ML2 | 2,5 | 3 | 50 | 11 | | 27303 | 27300 | | |
| | SB-42ML3 | 2,5 | 3 | 75 | 11 | | 27328 | 27325 | | |
| | SB-ECOM | 3 | 3 | 38 | | | | 21525 | | |
| | SB-43M | 3 | 3 | 38 | 14 | | 21503 | 21500 | | |
| | SB-43ML2 | 3 | 3 | 50 | 14 | | 27353 | 27350 | | |
| | SB-43ML3 | 3 | 3 | 75 | 14 | | 27378 | 27375 | | |
| | SC-41M | 2,5 | 3 | 38 | 11 | | 22253 | 22250 | | |
| | SC-42M | 3 | 3 | 38 | 14 | | 22278 | 22275 | | |
| | SC-42ML2 | 3 | 3 | 50 | 14 | | 27453 | 27450 | | |
| | SC-42ML3 | 3 | 3 | 75 | 14 | | 27478 | 27475 | | |
| | SD-41M | 2,5 | 3 | 38 | 2,3 | | 22778 | 22775 | | |
| | SD-42M | 3 | 3 | 38 | 2,5 | | 22803 | 22800 | | |
| | SD-42ML2 | 3 | 3 | 50 | 2,5 | | 27553 | 27550 | | |
| | SD-42ML3 | 3 | 3 | 75 | 2,5 | | 27578 | 27575 | | |
| | SE-41M | 3 | 3 | 38 | 5,5 | | 23153 | 23150 | | |
| | SE-41ML2 | 3 | 3 | 50 | 5,5 | | 27603 | 27600 | | |
| | SE-41ML3 | 3 | 3 | 75 | 5,5 | | 27628 | 27625 | | |
| | SF-41M | 3 | 3 | 38 | 6 | | 23678 | 23675 | | |
| | SF-42M | 3 | 3 | 38 | 12,7 | | 23703 | 23700 | | |
| | SF-42ML2 | 3 | 3 | 50 | 12,7 | | 27653 | 27650 | | |
| | SF-42ML3 | 3 | 3 | 75 | 12,7 | | 27678 | 27675 | | |
| | SG-41M | 3 | 3 | 38 | 6 | | 24153 | 24150 | | |
| | SG-43M | 3 | 3 | 38 | 9,5 | | 24203 | 24200 | | |
| | SG-44M | 3 | 3 | 38 | 12,7 | | 24228 | 24225 | | |
| | SG-44ML2 | 3 | 3 | 50 | 12,7 | | 27853 | 27850 | | |
| | SG-44ML3 | 3 | 3 | 75 | 12,7 | | 27878 | 27875 | | |
| | SH-41M | 3 | 3 | 38 | 6,3 | | 24553 | 24550 | | |
| | SH-41ML2 | 3 | 3 | 50 | 6,3 | | 27903 | 27900 | | |
| | SH-41ML3 | 3 | 3 | 75 | 6,3 | | 27928 | 27925 | | |
| | SJ-42M | 3 | 3 | 38 | 2,5 | | 24903 | 24900 | | |
| | SK-42M | 3 | 3 | 38 | 1,5 | | 25153 | 25150 | | |
| | SL-41M | 3 | 3 | 38 | 9,5 | 8° | 25403 | 25400 | | |
| | SL-42M | 3 | 3 | 38 | 12,7 | 8° | 25428 | 25425 | | |
| | SL-42ML2 | 3 | 3 | 50 | 12,7 | 8° | 27953 | 27950 | | |
| | SL-42ML3 | 3 | 3 | 75 | 12,7 | 8° | 27978 | 27975 | | |
| | SM-41M | 3 | 3 | 38 | 8,9 | 12° | 25678 | 25675 | | |
| | SM-42M | 3 | 3 | 38 | 11 | 14° | 25703 | 25700 | | |
| | SM-42ML2 | 3 | 3 | 50 | 11 | 14° | 28053 | 28050 | | |
| | SM-42ML3 | 3 | 3 | 75 | 11 | 14° | 28078 | 28075 | | |
| | SM-43M | 3 | 3 | 38 | 16 | 7° | 25728 | 25725 | | |
| | SN-41M | 2,5 | 3 | 38 | 3 | 10° | 26028 | 26025 | | |
| | SN-42M | 3 | 3 | 38 | 4 | 10° | 26053 | 26050 | | |



**Mold, Tool & Die Making Burs
Solid Carbide**



**Limas rotativas para moldes,
herramientas y matrices
Metal duro**







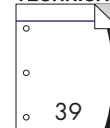



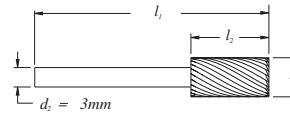

**Fraises-limes pour moulistes,
outils et matrices
Carbure monobloc**

TECHNICAL



6,3mm



| Tool No. | ød ₁ mm | ød ₂ mm | l ₁ mm | l ₂ mm | α | EDP No. | |
|---|-----------------------|-----------------------|----------------------|----------------------|-----|---------|-------|
| | | | | | | 6 | 3 |
|  SA-51M | 6,3 | 3 | 50 | 12,7 | | 20678 | 20675 |
|  SB-51M | 6,3 | 3 | 43 | 4,7 | | 21553 | 21550 |
|  SC-51M | 6,3 | 3 | 50 | 12,7 | | 22303 | 22300 |
|  SD-51M | 6,3 | 3 | 44 | 5 | | 22828 | 22825 |
|  SE-51M | 6,3 | 3 | 47 | 9,5 | | 23178 | 23175 |
|  SF-51M | 6,3 | 3 | 50 | 12,7 | | 23728 | 23725 |
|  SG-51M | 6,3 | 3 | 50 | 12,7 | | 24253 | 24250 |
|  SM-51M | 6,3 | 3 | 54 | 12,7 | 22° | 25753 | 25750 |
|  SN-51M | 6,3 | 3 | 44 | 6 | 10° | 26078 | 26075 |

E

Mold, Tool & Die Making Burs
6,3mm Head - 3mm Shank Braze Construction
5mm/4mm Head - 3mm Shank - Solid Carbide

ES









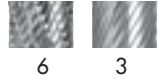



Limas rotativas para hacer moldes, herramientas y matrices
Cabeza de 6.3mm - Mango de 3mm con construcción de soldadura de bronce
Cabeza de 5mm/4mm - Mango de 3mm - Metal duro

FR

Fraises-limes pour mouliste, outils et matrices
Tête de 6,3mm - Queue de 3mm - Brasées
Tête de 5mm/4mm - Queue de 3mm - Carbone monobloc

4mm / 5mm



| Tool No. | ød ₁ mm | ød ₂ mm | l ₁ mm | l ₂ mm | α | EDP No. | |
|--|-----------------------|-----------------------|----------------------|----------------------|-----|---------|-------|
| | | | | | | 6 | 3 |
|  SA-52M | 4 | 3 | 38 | 12,7 | | 20703 | 20700 |
|  SA-53M | 5 | 3 | 38 | 12,7 | | 20728 | 20725 |
|  SC-52M | 4 | 3 | 38 | 12,7 | | 22328 | 22325 |
|  SC-53M | 5 | 3 | 38 | 12,7 | | 22353 | 22350 |
|  SD-52M | 4 | 3 | 38 | 3,4 | | 22840 | 22837 |
|  SD-53M | 5 | 3 | 38 | 4,7 | | 22853 | 22850 |
|  SE-53M | 5 | 3 | 38 | 7,1 | | 23203 | 23200 |
|  SF-53M | 5 | 3 | 38 | 12,7 | | 23753 | 23750 |
|  SG-53M | 5 | 3 | 38 | 12,7 | | 24278 | 24275 |
|  SH-53M | 5 | 3 | 38 | 9,5 | | 24603 | 24600 |
|  SL-53M | 5 | 3 | 38 | 12,7 | 14° | 25453 | 25450 |
|  SM-53M | 5 | 3 | 38 | 12,7 | 16° | 25778 | 25775 |
|  SN-53M | 5 | 3 | 38 | 6,3 | 10° | 26103 | 26100 |

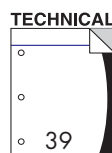

Bur Sets - Solid Carbide - Metric

Juegos de limas rotativas - Carburo sólido • Jeux de fraises-limes - Carbone monobloc



Solid Carbide Tools

#6M

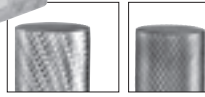

6

EDP No.
28211



3

EDP No.
28210

GB

SET #6M - Includes Eight Tool Numbers: SA-5M, SC-3M, SC-5M, SD-5M, SF-3M, SF-5M, SG-3M, SL-4M

ES

Estuche #6M - Incluye ocho herramientas número: SA-5M, SC-3M, SC-5M, SD-5M, SF-3M, SF-5M, SG-3M, SL-4M

FR

Coffret No 6M - Comprend huit numéros d'outils: SA-5M, SC-3M, SC-5M, SD-5M, SF-3M, SF-5M, SG-3M, SL-4M

#1M



6

EDP No.
28201



3

EDP No.
28200

GB

SET #1M - Includes Tool No.: SA-42M, SA-43M, SC-41M, SC-42M, SD-42M, SE-41M, SF-42M, SG-43M, SH-41M, SL-42M, SM-42M, SN-42M

Long Shank Bur Set #8M - Includes Tool No.: SA-1ML6, SA-5ML6, SC-1ML6, SC-5ML6, SD-1ML6, SF-1ML6, SG-1ML6, SL-1ML6

ES

Estuche #1M - Incluye herramientas número: SA-42M, SA-43M, SC-41M, SC-42M, SD-42M, SE-41M, SF-42M, SG-43M, SH-41M, SL-42M, SM-42M, SN-42M

Estuche #8M - Incluye herramientas número: SA-1ML6, SA-5ML6, SC-1ML6, SC-5ML6, SD-1ML6, SF-1ML6, SG-1ML6, SL-1ML6

FR

Coffret No 1M - Comprend les outils N°: SA-42M, SA-43M, SC-41M, SC-42M, SD-42M, SE-41M, SF-42M, SG-43M, SH-41M, SL-42M, SM-42M, SN-42M

Coffret No 8M - Comprend les outils N°: SA-1ML6, SA-5ML6, SC-1ML6, SC-5ML6, SD-1ML6, SF-1ML6, SG-1ML6, SL-1ML6

#8M



6

EDP No.
28215



3

EDP No.
28214

E

Fiberglass Routers Solid Carbide

For Fiberglass And Non-Metallic Materials

STYLE A: No End Cut, STYLE B: Bur End,
STYLE C: End Mill End, STYLE D: Drill End

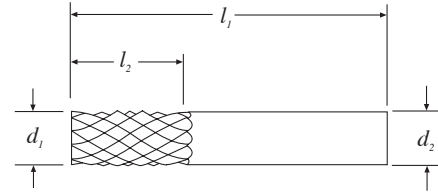

ES

Fresa Para fibra de vidrio

Metal duro Para fibra de vidrio y otros materiales

no metálicos. ESTILO A: Sin corte frontal,

ESTILO B: Con punta de lima rotativa,

ESTILO C: Con punta de fresa,

ESTILO D: Con punta de broca

FR

Fraises pour fibre de verre

Carbure monobloc Pour fibres de verre et

matières non-métalliques. Type A: sans taille en

bout, Type B: taille en bout comme fraise-lime,

Type C: taille en bout comme fraise,

Type D: taille en bout comme foret

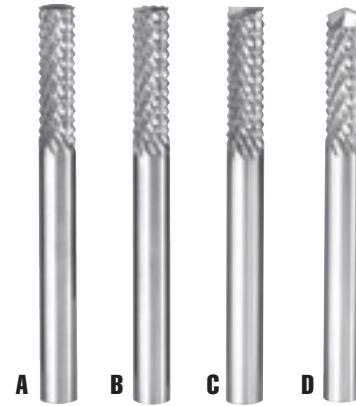

| Tool No. | ød ₁ mm | ød ₂ mm | l ₁ mm | l ₂ mm | EDP No. | EDP No. | EDP No. | EDP No. |
|----------|--------------------|--------------------|-------------------|-------------------|---------|---------|---------|---------|
| FGR-1M | 1,6 | 3 | 38 | 5 | 83001 | 83015 | 83030 | 83045 |
| FGR 1-1M | 2,4 | 3 | 38 | 9,5 | 83002 | 83016 | 83031 | 83046 |
| FGR-2M | 3 | 3 | 38 | 12 | 83003 | 83017 | 83032 | 83047 |
| FGR-3M | 4 | 4 | 50 | 16 | 83004 | 83018 | 83033 | 83048 |
| FGR-4M | 4 | 6 | 50 | 16 | 83005 | 83019 | 83034 | 83049 |
| FGR-5M | 6 | 6 | 50 | 19 | 83006 | 83020 | 83035 | 83050 |
| FGR-6M | 6 | 6 | 63 | 19 | 83007 | 83021 | 83036 | 83051 |
| FGR 6-1M | 6 | 6 | 75 | 25 | 83008 | 83022 | 83037 | 83052 |
| FGR-7M | 8 | 8 | 63 | 25 | 83009 | 83023 | 83038 | 83053 |
| FGR-8M | 10 | 10 | 75 | 25 | 83010 | 83024 | 83039 | 83054 |
| FGR-9M | 12 | 12 | 75 | 25 | 83011 | 83025 | 83040 | 83055 |

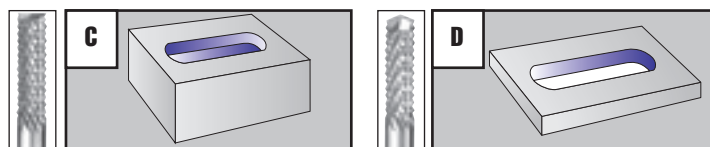
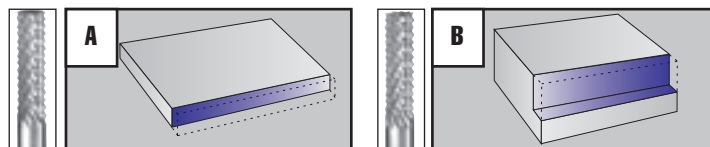

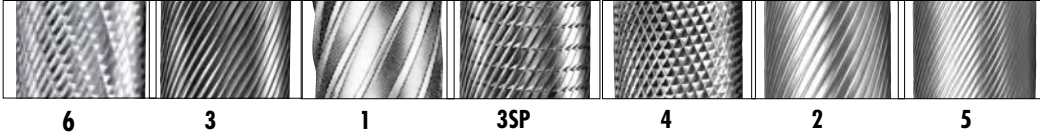

E Basic Fluting Styles for Carbide Burs

- 6 Double Cut:** Very efficient stock removal. Creates a small chip. Good finish. Excellent operator control.
- 3 Single Cut:** General purpose fluting. Produces long chips.
- 1 Nonferrous:** For nonferrous materials. Aggressive stock removal.
- 3SP Chip Breaker:** Provides breakdown in chips. Better control.
- 4 Diamond Cut:** For heat treated and tough alloy steels where control is important. Creates a powder-like chip. Excellent finish.
- 2 Coarse Cut:** Provides large flute area for softer ferrous materials. Fast stock removal.
- 5 Fine Cut:** For general use on hard materials requiring a fine finish.

ES Estilos básicos de filos en las limas rotativas de carburo sólido

- 6 Diente Cruzado / Corte Doble:** Remueve el material en forma extremadamente eficaz. Produce virutas pequeñas. Buen acabado. Excelente control de operación.
- 3 Diente Simple / Corte Simple:** Para uso general. Produce virutas largas.
- 1 Diente Aluminio / Corte No Ferroso:** Para materiales no ferrosos. Remueve material extremadamente rápido.
- 3SP Rompevirutas:** Quebra las virutas. Mejora el control.
- 4 Diente Diamante / Corte Diamante:** Para aleaciones de acero tratadas térmicamente y aleaciones de acero duras donde el control es importante. Convierte las virutas en polvo. Excelente acabado.
- 2 Diente Grueso / Corte Grueso:** Suministra una gran área de cortes para materiales ferrosos mas suaves. Remueve el material rápidamente.
- 5 Diente Fino / Corte Fino:** Para uso general en materiales duros que requieren un acabado fino.

FR Types de dentures de base pour les fraises-limes

- 6 Denture croisée:** Matière enlevée de façon très efficace. Petits copeaux. Bonne finition. Excellent contrôle opérateur.
- 3 Denture standard:** Denture à usage général. Produit de longs copeaux.
- 1 Denture alu:** Pour métaux non-ferreux. Enlèvement agressif de matière.
- 3SP Denture brise-copeaux:** Rupture des copeaux. Meilleur contrôle.
- 4 Denture diamant:** Pour aciers trempés et alliage dur, où il est important d'avoir un bon contrôle. Crée des copeaux très fins. Excellente finition.
- 2 Denture à grand rendement:** Sur une grande surface pour des métaux non-ferreux plus tendres. Enlèvement rapide de matière.
- 5 Denture fine:** Utilisé pour la finition fine des métaux durs.

Solid Carbide Bur Application Information

Estilos básicos de filos en las limas rotativas de carburo

Informations sur l'application des fraises-limes en carbure monobloc



| Material / Materiales / Matière | 6 | 3 | 1 | 3SP | 4 | 2 | 5 |
|--|---|---|---|-----|---|---|---|
| Aluminum / Aluminio | | | • | | | | |
| Brass, Bronze Copper / Latón, Bronce, Cobre / Laiton, bronze, cuivre | • | | | • | | • | |
| Carbon Fiber / Fibra de Carbono / Fibre de carbone | | • | | | | • | |
| Fiberglass / Fibra de Vidrio / Fibre de verre | | | | | • | | |
| Cast Iron / Hierro Fundido / Fonte | • | • | | • | | | |
| Plastics / Plásticos / Matières synthétiques | | | • | | | • | |
| Hard Rubber / Látex duro / Caoutchouc durci | | | | | | • | |
| Steel, 40-55 Rc / Acero 40-55 Rc / Acier, 40-55 Rc | • | • | | • | • | | • |
| Steel, 55-60 Rc / Acero 55-60 Rc / Acier, 55-60 Rc | • | • | | • | • | | • |
| Steel, Carbon / Acero, Carbono / Acier au carbone | • | • | | • | • | | |
| Steel, Nickel Chrome / Acero, Niquel Cromo / Acier au nickel-chrome | • | • | | • | • | | |
| Steel, Stainless / Acero, Inoxidable / Acier inoxydable | • | • | | • | • | | • |
| Steel, Weldments / Acero, Soldaduras / Acier de soudure | • | • | | • | • | | |
| Titanium / Titanio / Titane | • | • | | • | | | |
| Zinc / Zinc / Zinc | | | • | | | • | |

Bur Speed Recommendations Extra-long burs with 1/4" shanks over 6" long and 1/8" shank burs over 2" long should be used at reduced speeds.

Recomendaciones para velocidad de las limas rotativas

Al utilizar limas rotativas extra largas con zancos de 1/4" y 6" de largo, y al utilizar las de 1/8" con más de 2" de largo se debe reducir la velocidad de la máquina.

Vitesse de rotation des fraises-limes Les fraises limes longues à queue de plus de 6" de long et les fraises limes à queue de 1/8" de plus de 2" de long, doivent être utilisées à vitesse réduite.

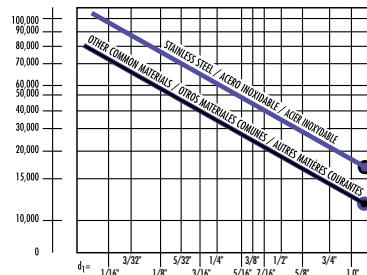

SGS PRODUCTS ARE SOLD IN OVER 60 COUNTRIES:



**UNITED STATES OF AMERICA
SGS TOOL COMPANY**

World Headquarters
P.O. Box 187
55 South Main Street
Munroe Falls, Ohio 44262 U.S.A.
Phone: (330) 688-6667
Customer Service –
US and Canada: (330) 686-5700
Fax – US and Canada: (800) 447-4017
International Fax: (330) 686-2146
E-mail: webmaster@sgstool.com

**CANADA
SGS TOOL CANADA**

171 Northport Road, Unit #3
Port Perry, ON L9L 1B2
Phone: 905/982-0888
Fax: 905/982-0488
E-mail: sgstool@bellnet.ca

**UNITED KINGDOM
SGS CARBIDE TOOL (UK) LTD.**

Unit 1, The Metro Centre
Toutley Road
Wokingham, Berkshire
RG41 1QW England
Phone: (44) 1189-795-200
Fax: (44) 1189-795-295
E-mail: sales@sgstool.co.uk

**FRANCE
SGS-PROMECA**

36, Rue Des Landes
Chatou F78400
Phone: (33) 13952-8280
Fax: (33) 1305-34919
E-mail: sgspromeca@sgstool.fr

**GERMANY
SGS TOOL EUROPE GmbH**

Hitdorfer Strasse 10C
Langenfeld D40764
Phone: (49) 2173-9100-91
Fax: (49) 2173-9100-99
E-mail: info@sgs-tool.de

**EASTERN EUROPE
SINTCOM**

Phone: (359) 283-64421
Fax: (359) 283-64421
E-mail: sintcom@cablebg.net

**RUSSIA
HALTEC**

Phone: (7) 842-241-4717
Fax: (7) 842-241-7619
E-mail: info@halte.ru

**CHINA
SGS TOOL SHANGHAI**
Phone: (86) 21-58682809-107
Fax: (86) 21-58682803
E-mail: sgsshanghai@126.com

SGS PRODUCTS ARE DISTRIBUTED BY:



Suggested Retail Price \$4.95
Catalog EDP No. 00033 – Rev. 3/2007
©2007 SGS Tool Company

SGS[®]

An ISO 9001 : 2000 Certified Company

Solid Carbide Tools

www.sgstool.com